

102/1470 (4") · f/14.4

127/1900 (5") · f/14.9

Maksutov-Cassegrain GoTo telescope

Art. No. 4701102
4701127





General warnings

EN



This operating instruction booklet is to be considered as part of this device.

Read the safety instructions and the operating manual carefully before using this device.

Keep this manual in a safe place for future reference. If this device is sold or passed on, these operating instructions must be passed on to each subsequent owner/user of the product.

⚠ [WARNING:]DANGER of bodily injury!

Never look directly at, or near the sun with this device. There is a risk of PERMANENT BLINDNESS if this occurs!

Children should only use this device under supervision. Keep packaging materials (plastic bags, rubber bands, etc.) away from children! There is a DANGER OF CHOKING [These pose a CHOKING HAZARD]

⚠ RISK OF ELECTRIC SHOCK!

This unit contains electronic parts that are powered by a power source (AC adapter or batteries). Never leave children unattended when handling the device! Please follow the

instructions carefully and do not attempt to power this device with anything other than power sources recommended in this manual, otherwise there is a DANGER OF A ELECTRIC SHOCK!

Never bend, squeeze or pull power cables, connecting cables, extensions or connectors. Protect cables from sharp edges and heat. Check this device, cables and connections for damage before use. Never attempt to operate a damaged device, or a device with damaged electrical parts! Damaged parts must be replaced immediately by an authorized service agent.

⚠ FIRE/EXPLOSION HAZARD

Do not expose this device to high temperatures. Use only the recommended batteries. Do not short-circuit the device or batteries or dispose of in fire! Excessive heat and improper handling can cause short circuits, fires and even explosions!

⚠ FIRE HAZARD!

Do not expose this device - especially the lenses - to direct sunlight! Focusing of sunlight could cause fires.

DANGER of material damage!

Do not disassemble the device! In the event of a defect, please contact your dealer. They will contact our Service Center and can arrange the return of this device for repair if necessary.

Do not subject the device to excessive vibrations.

The manufacturer accepts no liability for voltage damage as a result of incorrectly inserted batteries, or the use of an unsuitable mains adapter!



Delivery content

Fig. 1



Fig. 2



MCX GoTo Telescope (Fig. 2)

- | | | |
|----------------------------------------------------------------------------------------------------------------------------------------------------------------------------------------------------------------------------------------------------------------------------------------------------------------------------------------------------------------------------------------------------------|----------------------------------------------------------------------------------------------------------------------------------------------------------------------------------------------------------------------------------------------------------------------------------------------------------------------------------------------------------------------------------------------------------------------------|--------------------------------------------------------------------------------------------------------------------------------------------------------------------------------------------------------------------------------------------------------------------------------------------|
| <ul style="list-style-type: none"> 1. Eyepiece 2. LED viewfinder 3. Set screw for the eyepiece holder 4. Eyepiece holder with 90° view 5. Optical tube with 102 mm or 127 mm aperture 6. Vertical Clutch Knob (decl. clamp.) 7. Mounting fork 8. Focus knob 9. Horizontal Clutch Lever (right ascension clamping) | <ul style="list-style-type: none"> 10. Aux Input Port 11. Motor housing and mount base 12. Circular bubble level 13. Setting circle for right ascension (RA) - around telescope base. 14. Flip mirror control 15. Photo adapter connector port (under circular cover) 16. Setting circle for declination (DEC) - on the left arm of the mounting fork | <ul style="list-style-type: none"> 17. Adjustment knobs for the LED viewfinder 18. Mount for the LED viewfinder 19. Computerised Handbox with LED display 20. Lens cap 21. Field tripod with adjustable polar wedge and nylon field bag |
|----------------------------------------------------------------------------------------------------------------------------------------------------------------------------------------------------------------------------------------------------------------------------------------------------------------------------------------------------------------------------------------------------------|----------------------------------------------------------------------------------------------------------------------------------------------------------------------------------------------------------------------------------------------------------------------------------------------------------------------------------------------------------------------------------------------------------------------------|--------------------------------------------------------------------------------------------------------------------------------------------------------------------------------------------------------------------------------------------------------------------------------------------|

Fig. 3

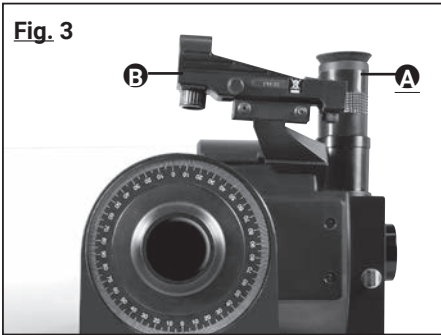

What's Included:

The MCX is supplied as far as possible pre-assembled from the factory. You can start your observations in only a few minutes following these instructions carefully. When opening the package for the first time, check carefully that all the parts listed below are included (Fig. 1):

- MCX GoTo Telescope with Fork Mounting (A)
- Computerised Handbox with LED display and coiled (curly) cable (B)
- LED viewfinder (C)
- 26mm Super Plössl (SP) Eyepiece (D)
- Allen key (E)
- Field tripod (F)

Fig. 4

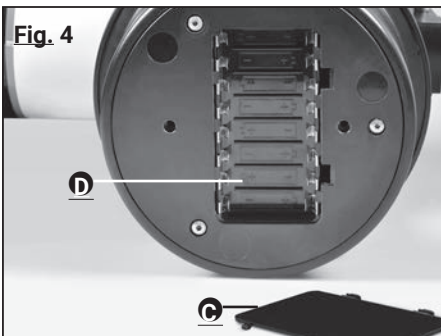

Some accessories have been packed separately for protection. Check all boxes for their contents.

Required batteries:

- for the LED viewfinder: 1x 3V button cell, type CR2032 (C) (included in delivery)
- for the telescope: 8x 1.5V batteries, type AA (not included)

! IMPORTANT NOTE!

Do not use rechargeable AA batteries, as these will not give out the correct voltage for use.

Fig. 5

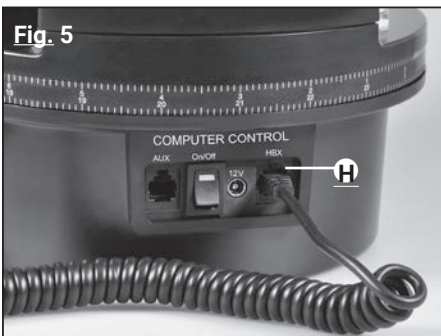

Quick Start Guide

1. Remove the MCX from its packaging and place it on a firm level surface. Insert the eyepiece (A, Fig. 3) and attach the finder (B, Fig. 3) Make sure these are attached firmly, but do not overtighten their respective attachment screws (touch tightness will do).
2. Now gently lay the MCX on its side in a stable position (be careful that the telescope does not roll off the surface) and remove the cover of the battery compartment (C, fig. 4) on the underside of the motor housing/base. Insert eight AA batteries (not supplied) into the battery compartment (D, fig. 4) on. [not sure this "on." is needed in the English version?]

! IMPORTANT NOTE!

When inserting the batteries, pay attention to their correct orientation and polarity.

Fig. 6

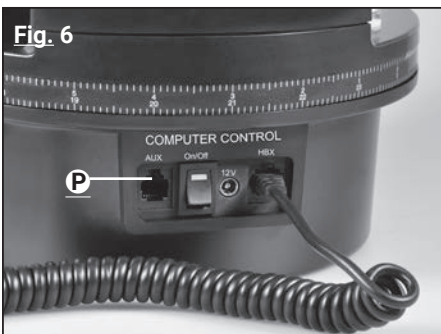

3. Close the lid and return the telescope to its upright position.

4. (3.) Make sure that the power supply switch (P, fig. 6) is set to "OFF" on the control panel of the telescope. Remove the handheld computer (19, fig. 2) from its packaging and connect it to the HBX connector (H, fig.5). Tighten the vertical and horizontal clutches (6 and 9, Fig. 2). Remove the dust cover from the front end of the tube.

! IMPORTANT NOTE!

The telescope has mechanical end stops in the horizontal and vertical axis to prevent damage to the telescope. [Please do not attempt to slew the telescope beyond these as this may cause damage to the motors and/or gearing.] For more information, refer to chapter "Alignment of the MCX to the celestial pole" on pages 19 and 20.)

Fig. 7

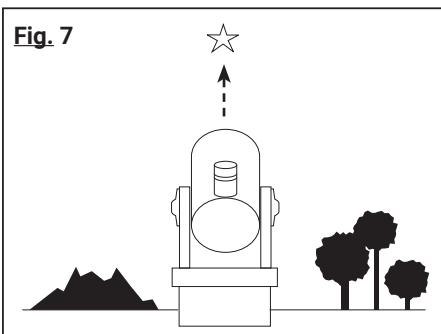

5. (4.) Switch the power supply switch (P, fig. 6) on the control panel of the computer to the "ON" position. On the LCD display of the Handbox the copyright message will appear and then "Initialize..."; the operating system has now booted up.

6. (5.) The handheld computer now prompts you to enter basic data and confirm each by pressing the ENTER key. You can now use the arrow keys to rotate the telescope up, down, right or left. If you want to change the slewing speed of the telescope, press the numeric keys. "9" sets the highest speed, "1" sets the lowest speed. See page 17 for details.

7. (6.) To centre an object, first adjust the LED viewfinder (see page 11). Use the arrow keys on the handheld computer to move the telescope until the object is centered in the center of the eyepiece's field of view. Turn the focusing knob of the telescope (8, fig. 2) to focus on the object.



Assembly

Fig. 8

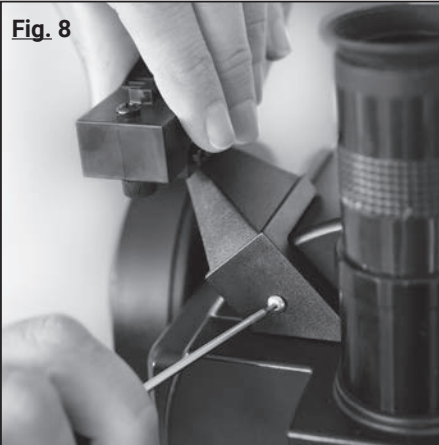

Installation of the LED viewfinder

! IMPORTANT NOTE!

Before each observation you should make sure that the tilting mirror is in the "UP" position (14, Fig. 2). For further information please refer to chapter "Operating the tilting mirror" on page 11.

Assembling the MCX Telescope

To operate the MCX, you need an additional eight AA batteries - the assembly takes place in just four steps:

1. Mount the LED viewfinder using the Allen key as shown in Fig. 8 shown on telescope tube.

! IMPORTANT NOTE!

Make sure that the mirror surface of the LED viewfinder points towards the tube opening when attaching it.

For more information on the orientation of the viewfinder, refer to chapter "Use - The LED Viewfinder".

Fig. 9

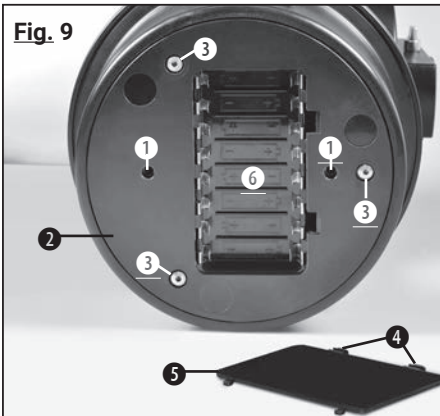

Bottom view of the MCX:

(1) Thread for the tripod; (2) Drive housing; (3) Housing screws (!Only to be opened by authorized service technician!); (4) Holding clamps; (5) Battery compartment cover; (6) Battery compartment

2. Insert the SP 26mm eyepiece (1, fig. 2) into the eyepiece socket (4, fig. 2). Tighten the clamping screw (3, fig. 2) to touch tightness (do not overtighten).

3. The battery compartment of the telescope (6, fig. 9) is located at the bottom of the base motor housing. Bring the telescope, as pictured in Fig. 9, into a secure lateral position. Simultaneously press the two retaining clips (4, fig. 9) and open the battery compartment. Lift the battery compartment cover (5, fig. 9) from the base housing. Now insert the eight AA batteries into the battery compartment, observing their +/- orientation, which is indicated on the battery compartment base.

Alternatively, use the recommended power supply unit (art. no. 0455121). Connect it to the female 12V jack socket connector (4, fig. 10) found on the side panel.

! WARNING!

Insert the batteries with the great care! Do not insert the batteries upside down, do not mix old and new batteries and only use batteries of the same type. Do not use rechargeable batteries! If these precautions are not followed, or if batteries (even single ones and only for a short time) are inserted the wrong way round, irreversible damage may occur to the MCX itself, which is not covered by the telescope's warranty! Further damage caused by leaking, heating, possibly burning or bursting batteries, cannot be covered by the warranty either!

Fig. 10

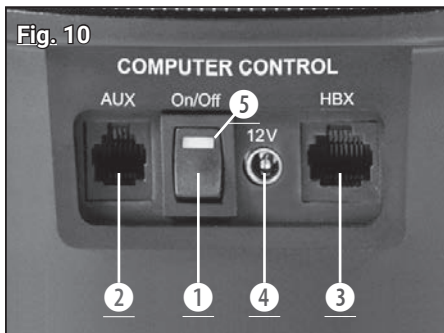

Interface field: (1) ON/OFF switch; (2) accessory port*; (3) HBX connector for handheld computer; (4) 12V connector; (5) power supply indicator lamp

4. Place the telescope upright on a table. Make sure that the power supply switch on the side panel (1, fig. 10) is in the OFF position. Connect the coiled cable of the handheld computer to the HBX socket (3, fig. 10).

The assembly of the MCX telescope is now complete. Now the assembly on the field tripod follows.

*not active on these models, as no suitable accessories currently available



Assembly

Fig. 11



Step one: Spread the tripod legs (1) as far as they will go.

Fig. 12

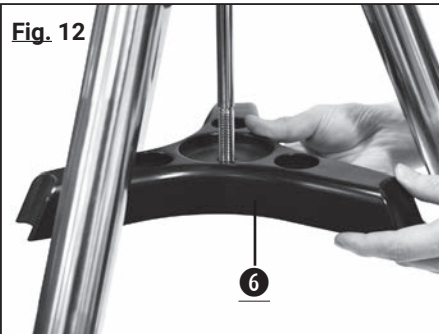

Step two: Slide the spreader clasp (6) over the central threaded rod

Fig. 13

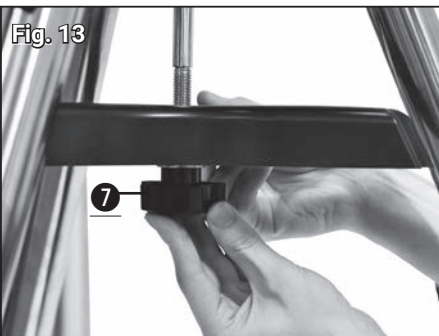

Step three: Slide the washer and then the lock nut (7) onto the threaded rod. Tighten the nut.

Fig. 14

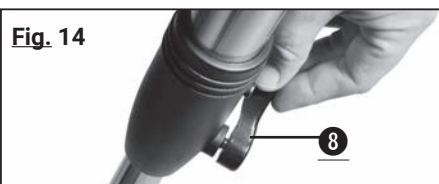

Step four: Adjust the height of the tripod by loosening the locking screw (8) and pulling out the inner tripod leg to the desired length. Then tighten the locking screw (8) again.

The field tripod

With the field tripod a MCX telescope can be mounted in Alt/Az mode, as well as Equatorially. An equatorial wedge, comprising of a tilt plate and height adjustment bar, is built into the tripod

The parts:

- Tripod with attached tilting plate and height adjustment bar unit with clamp.
- Two mounting screws for mounting the MCX telescope on the tilt plate
- spreader clasp, spring, two washers and knurled nut to attach the spreader clasp to the tripod
- Three clamping bolts for height adjustment of the tripod legs

Assembling the tripod

1. Spread the legs of the tripod (1, Fig. 11) as far as they will go.
2. Slide the spreader clasp (6, Fig. 12) over the central threaded rod.
3. Slide the washer and then thread the knurled nut (7, fig. 13) on to the threaded rod. Tighten the nut.
4. Adjust the height of the tripod by loosening the leg locking bolts (8, fig. 14) and pull out the inner tripod leg to the desired length. Then tighten the locking bolts (8) until the leg is firmly held in place.

! IMPORTANT NOTE!

Tighten the central knurled nut until the tripod legs are stable and do not wobble or slip (do not overtighten).

Alt/Azimuth, or Equatorial placement?

The rotation of the earth causes astronomical objects to proscribe an arc as they appear travel through the sky. This apparent movement is not noticeable when observed with the naked eye. When observing with a telescope like the MCX, however, this speed of movement seems quite high. If the telescope drive is not activated, celestial objects disappear from the field of view of the eyepiece within 15 to 60 seconds. The speed of the movement depends on the magnification used. This movement can be compensated by positioning the telescope correctly and activating the drive. The two basic ways to mount a telescope are Altitude/Azimuth (up/down – left/right) and Equatorial.. When using the handheld computer, the MCX usually does not have to be mounted Equatorially. The handheld computer enables the Alt/Az tracking of the telescope for practically all types of observations.



Assembly

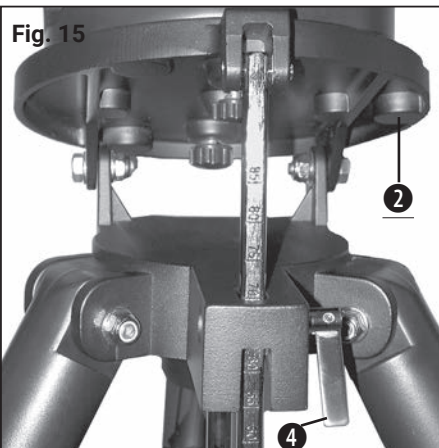

Loosen the pole height clamping screw.



Mounting the MCX on the tilting plate of the tripod.



Azimuthal alignment: Tilt plate and tube are horizontal. The tube opening faces north (N)

Alt/Az Positioning

The Alt/Az position of the telescope is ideal for quick observation of terrestrial and astronomical objects. The telescope is swivelled in horizontal and vertical direction.

Alt/Az mounting of the telescope

1. Loosen the height adjustment bar clamping bolt (4, fig. 15) and adjust the tilt plate (2, fig. 15) facing slightly upwards so that you can easily reach the underside of the plate. Now retighten the tilt plate height adjustment bar clamping screw so that the unit cannot slip when the telescope is mounted (see Fig. 15).
2. Place the telescope on the tilt plate so that the side panel is to the left of the pole height adjustment (1, fig. 17). Then place the other threaded hole over the other fixing screw and hand-tighten both screws (see figure). 15).
3. Hold the telescope by the tilting plate and carefully loosen the tilt plate height adjustment bar screw (4, fig. 15) and lower the tilt plate until it is horizontal (tilt the plate down to the stop, this is the horizontal position). Retighten the height adjustment bar screw to lock the tilt plate in a horizontal position.
4. Release the altitude axis clutch on the telescope's fork arm and adjust the optical tube as closely as possible to 0 degrees (horizontal) on the altitude setting circle and then tighten the clamp again.
5. Release the azimuth axis clutch and slowly rotate the optical tube counterclockwise by hand until it reaches the mechanical end stop.
6. Then slowly rotate the optical tube back again by hand until the telescope opening points exactly north and tighten the clamp firmly again.
7. You have now reached the azimuthal start position. Now start an alignment method (1-star, 2-star, etc.) to use the Goto function or move the telescope manually with the direction keys.

Operation of an azimuthally mounted telescope

Your MCX is now azimuthally mounted on the field tripod (Fig. 17). The telescope can be swivelled horizontally and vertically. When using the handheld computer (standard equipment on the MCX-102/127), the MCX can be used in azimuthal mode. The handheld computer then automatically tracks celestial objects simultaneously in horizontal and vertical axes after a successful 1-star, 2-star, or 3-star alignment has been performed (see p. 24). If you set up the telescope azimuthally, the direction of the tripod is arbitrary. The legs of the field tripod can point in any direction. However, the tilting plate and the tube must be horizontal. The tube opening must also face north (N, Fig. 17).

! IMPORTANT NOTE!

To achieve a quick and precise horizontal alignment of the tripod, use the standard built-in circular bubble (12, fig. 2) the telescope mount. The tripod is sufficiently levelled as soon as the air bubble is within the circle mark.

Special features of the telescope

Practical Tips

- **Rotation limiter:** The telescopic base and the mounting fork are equipped with an internal "rotation limiter". The horizontal turnstile prevents the telescope from turning by more than 630°. This avoids damage to the internal wiring. The vertical pan lock ensures that the viewfinder does not move against the mounting fork when the telescope is tilted beyond the vertical 90° position. It also ensures that the optical tube never touches the base as soon as you tilt it deeper than 30°. Never attempt to move the telescope beyond these locks manually or by motor drive. You would damage your instrument with it.

- **Vertical clamping; declination pitch circle:** The actuation of the vertical clamping (6, fig. 2) is done with a knurled knob on the arm of the mounting fork to the right of the focusing knob (8, fig. 2) can find. Below this button a circular scale without numbers is mounted. Do not confuse this scale with the declination pitch circle (16, Fig. 2) on the opposite fork arm, which has a numerical scale and is used to search for astronomical objects.

- **Note on observations in closed rooms:** Although the telescope could occasionally be used to make observations at low magnification through an open or even closed window, the best observation is always made outside. Temperature differences between indoors and outdoors and/or the poor quality of most domestic windows are likely to cause highly distorted images in the telescope. Never expect high-resolution images under these conditions!

Telescope control

Fig. 18

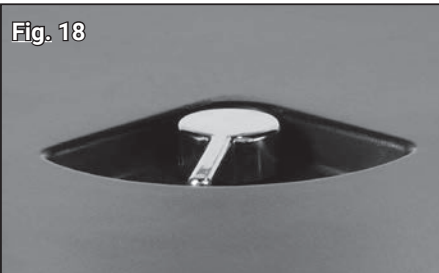

Horizontal clamping

The use of the MCX telescope is made easy by a consistently well thought-out arrangement of the functions and the manual operating options. Make sure that you have familiarized yourself with all the functions before starting the practical observation.

Horizontal clamping (9, Fig. 2 and Fig. 18): It influences the manual horizontal rotation of the telescope while the telescope rotates as shown in Fig. 2 is in upright position. If you operate the horizontal clamp counterclockwise, the telescope is released; it can now be rotated horizontally by hand without hindrance. As soon as you turn the horizontal clamp clockwise, block the manual horizontal movement. At the same time, however, the clutch of the horizontal drive is activated for use with the AutoStar #497 handheld computer. When the telescope is aligned with the celestial pole, the horizontal clamp serves as a right ascension or RA clamp (the term "right ascension" is explained in more detail on page 18).

Fig. 19



Vertical clamping

Vertical clamping (6, Fig. 2 and Fig. 19): It affects the manual vertical rotation of the telescope as it moves as shown in Fig. 2 is in upright position. If you operate the vertical clamp counterclockwise, the telescope is released; it can now be swivelled vertically unhindered by hand. As soon as you tighten the vertical clamp clockwise (hand tight only!), block the manual vertical movement. At the same time, however, the clutch of the vertical drive is activated for use with the handheld computer. When the telescope is aligned with the celestial pole, the vertical clamp serves as a declination or DEC clamp (the term "declination" is explained in more detail on page 18).

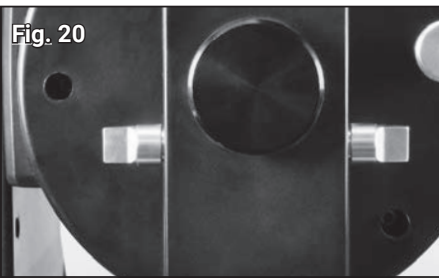

The Flip Mirror in the upright position.

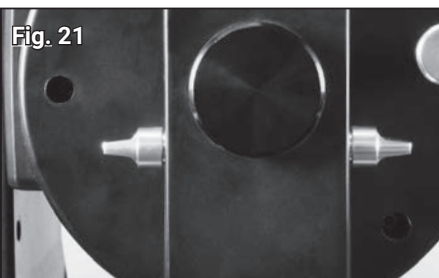

The Flip Mirror in the horizontal position.

The focus knob (8, fig. 2): It causes a fine internal movement of the main mirror in the telescope in order to achieve a precisely focused image. The MCX can focus on objects between a minimum distance of about 50m and infinity. Turn the focus knob clockwise to focus on distant objects; turn the focus knob counterclockwise to focus on closer objects.

Operation of the tilting mirror (Fig. 20): An optical plane mirror is built into the MCX. If the tilting mirror moves as shown in Fig. 20 is in the "UP" position, the light is deflected at a 90° angle to the eyepiece. If, on the other hand, the tilting mirror is in the "DOWN" position, this is shown in Fig. 21, the light passes straight through the telescope into the photo port (15, fig. 2). This allows you to use the telescope with an optional T-adapter for telephoto or astrophotography. More detailed information can be found in chapter "Optional accessories" on page 36.

! NOTE!

The tilting mirror is in the "UP" position when the knobs are vertically aligned, shown in Fig. 20. It is in the "DOWN" position when the knobs are aligned horizontally (parallel to the telescope tube), as shown in Fig. 21.

The interface field

The interface field (Fig. 22) on the MCX includes a connector for the standard handheld computer. In addition, there is a connector for the external power supply and an auxiliary socket (socket for accessories, see "Handheld computers" on page 22).

ON/OFF (1, fig. 22): When the ON/OFF switch is moved to the ON position, the red indicator lamp for the power supply lights up (5, fig. 22). The handheld computer and the telescopic drive are now supplied with power.

AUX (2, fig. 22): This accessory port is used to connect future accessories.

! NOTE!

The AUX port (2, fig. 22) at the interface is foreseen for future developments, but not currently active. Unfortunately there are no accessories available at the moment. We may inform you about new developments for this product on our website at www.bresser.de/download/Messier

! WATCH OUT!

Use of unauthorized products may damage the telescope electronics and void your warranty.

HBX (3, fig. 22): The HBX connector is used to connect the handheld computer using the supplied spiral cable.

12V (4, fig. 22): The 12V connector is intended for use with an external power supply. For more information, refer to chapter "Optional Accessories" on page 36. As soon as you use this alternative power supply, the internal batteries are disconnected from the circuit.

! NOTE!

If you do not use the instrument for a long time, always remove the batteries. This prevents damage from leaking battery acid.

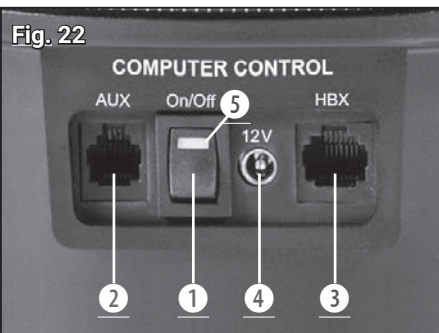

Interface field: (1) ON/OFF switch; (2) accessory port*; (3) HBX connector for handheld computer; (4) 12V connector; (5) power supply indicator lamp

*not active on these models, as no suitable accessories currently available

Fig. 23

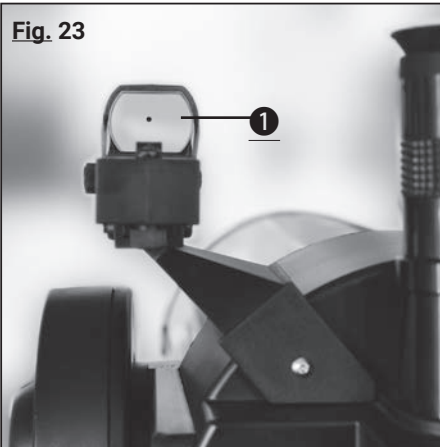

Using the LED Viewfinder

The LED viewfinder projects a red dot onto the mirror surface (1, fig. 24) and thus "before" the target. This makes it easier to adjust objects.

By turning the large knurled wheel, you can switch the LED viewfinder on or off and also adjust the brightness of the illuminated dot.

The viewfinder is aligned with the small knurled wheels on the lower and left side. Proceed as follows to align the unit correctly:

1. Insert the supplied 26mm eyepiece into the eyepiece holder. Look through the eyepiece and place a clearly visible object (moon, bright star) in the middle of it.
2. Turn on the LED viewfinder and aim at the same object. Use the two small knurled wheels to adjust the visible red illuminated dot until it is centered above the object (fig. 24). Eyepiece and illuminated dot are now matched to each other.

Fig. 24

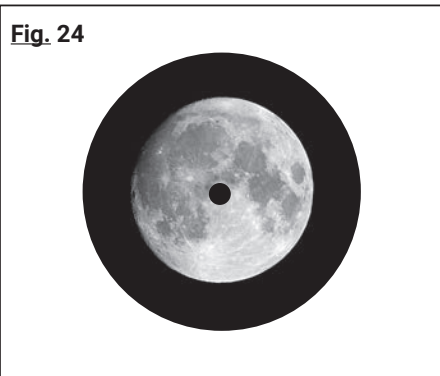

Fig. 37



Battery change for LED viewfinder

If the red dot on the mirror surface is not visible after switching on, the battery (type CR2032, 3V) of the viewfinder must be replaced. Proceed as follows:

1. Press the battery drawer labelled PUSH (fig. 37) and pull out the drawer on the other side (Fig. 38).

! NOTE!

Replace the battery only with a completely new, unused battery of the same type!

Fig. 38



2. Insert the battery into the battery drawer. Pay attention to the correct installation position and polarity of the new battery (fig. 39).

3. Push the drawer back into the shaft. The drawer can only be inserted correctly from one side.

Fig. 39

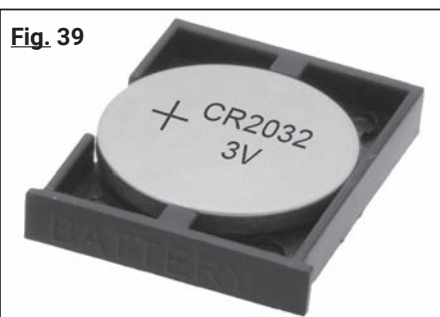



The first night

As a freshly baked telescope owner, she naturally wants to penetrate the depths of the universe immediately. Unfortunately, stargazing can only take place on clear nights. However, if the weather is not good, you still have some time to prepare for the first night. It makes sense if you are concerned with the construction of the device, which must also succeed in the dark. Perhaps you should also take one or two books at hand so as not to be unprepared for the challenges of heaven. You should always have these instructions at hand.

Then finally, after a long pause, the sky breaks open and gives a clear view of the starry sky. It is time to give the telescope the "FirstLight", as amateur astronomers call the "baptism" of the telescope in the open sky. This evening can be decisive whether you are infected by the fascination of the starry sky or whether you turn away from the hobby with frustration and disappointment because of annoying mishaps. In the age of space travel we are spoiled by astrophotographs taken by space probes and large telescopes. Science fiction films on television and in the cinema impress with breathtaking star worlds. The expectations towards the telescope are accordingly high. The first look through your telescope may therefore be sobering at first. Over time, however, you will notice that observing astronomical objects is an exciting and fascinating activity. So that the telescope does not become a bad investment, we as a telescope manufacturer have written a small guide for you, which should introduce you a little into this great hobby. We don't want to impart deep science - the market has enough literature for that - but we want to give a small practical instruction how to handle the telescope and what can be observed.

ASTRO-TIPPS!

- Versuchen you will find an observation site that is far away from bright light sources such as cities, streets or sports fields. If this is not always possible then choose a place where it is a little darker. All the darker, all the better.
- Geben you can accustom your eyes to the darkness for about 10 minutes. Give your eyes an observation break about every 10 to 15 minutes to avoid watery eyes and eye pain.
- Versuchen you do not use white light during an observation in the dark. Experienced observers only use red light in order not to lose the adaptation of the eye to darkness (dark adaptation of the eye). They either use the flashlight, or wrap red special foil around their lamps. Also note that when other observers are nearby, they do not handle white light. Never shine a lamp into a telescope through which you are watching!
- Ziehen you warm up. Hypothermia can quickly occur when sitting on cool days.
- Üben you the preparation of your equipment in the light, so that then in the dark every handle sits.
- Verwenden your 26mm eyepiece for earth observation or distant areas in the starry sky, such as open star clusters (e.g. Pleiades M45). Use a more magnifying eyepiece, such as a 9mm eyepiece, to see close things such as the rings of Saturn or craters on the moon.

Fig. 25



The handheld.

First observations

There is a dust cap in front of the front lens of your telescope. At the same time, press the two locking buttons slightly inwards and remove the dust cap. The MCX is now ready for terrestrial observation.

! NOTE!

After each observation, the dust cap should be replaced and the power to the telescope disconnected. Make sure that any trace of dew that may have set in during observation has evaporated before attaching the dust cap.

With the standard SP 26mm eyepiece, which you previously inserted into the eyepiece socket, you can achieve a magnification of 56x (MCX-102) or 76x (MCX-127) with your telescope. Please also read the chapter "What is magnification" on page 15.

All objects that you look at through the eyepiece are aligned upright in the telescope, but they are imaged upside down. The image orientation is discussed in more detail in the chapter "Terrestrial observations" on page 15. The tilting mirror (14, fig. 2) must be in the "UP" position so that you can observe an image in the telescope eyepiece at all (see also section "Operating the tilting mirror" on page 11!)

In order to experience the maximum viewing pleasure, it is essential that you familiarise yourself with the features of your MCX telescope and the functions of the handheld computer described below. Once you've worked through this chapter, your first observation is a simple earthly object - it should be a few hundred meters away, and it could be a telephone pole, a street lamp, or a church tower. First locate this object with the LED viewfinder before viewing it through the MCX telescope. Refer also to chapter "The LED Viewfinder" on page 12. Practice focusing on the subject with the focus knob (8, fig. 2) and retrieve it by pressing the arrow keys on your handheld computer (5, fig. 25) in the middle of the visual field.

Basic hints

With the MCX telescopes you can start observing immediately after unpacking. However, if you have first familiarized yourself with the basics of using the telescope, a subsequent observation will be much easier and more rewarding.

Eyepiece selection

The task of a telescope eyepiece is to magnify the image produced by the telescope's main optics. Each eyepiece has a specific focal length, which is specified in millimeters (mm). The smaller the focal length, the greater the magnification. Low magnification eyepieces offer a large field of view, bright and high-contrast images and relax your eyes during longer observation sessions. To adjust an object with the telescope, it is best to use a slightly magnifying eyepiece - such as the SP 26mm eyepiece supplied with the MCX. Only when the desired object is set and centered in the center of the field of view should you switch to an eyepiece with a larger magnification in order to enlarge the image as far as the current atmospheric conditions allow.

For terrestrial observation we recommend eyepieces with weaker magnification. Dust, warm air streaks and suspended particles in the air distort the images when higher magnifications are used.

For astronomical observations, low or high magnifications may be useful, depending on the object of observation. Eyepieces with smaller magnifications are used for large-area observations. On the other hand, high magnifications when observing details on the moon (e.g. craters) can provide very beautiful images. Even for planets, high magnifications with good visibility bring the best results.

! NOTE!

Seeing conditions change significantly from night to night. Air turbulence, which also occurs on apparently clear nights, can distort the images permanently. If an image appears blurry and poorly defined, step back to a lower magnifying eyepiece to achieve a better resolution (see figure). 26)

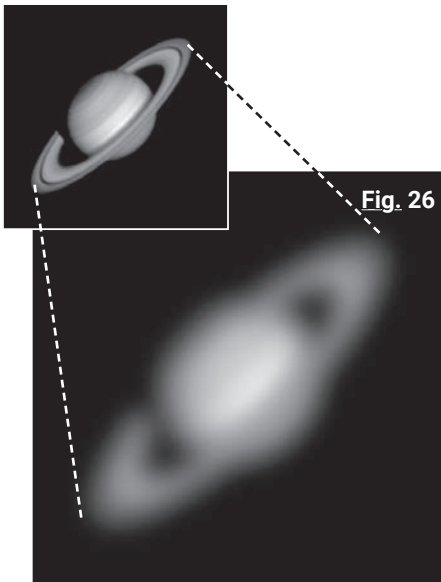

Fig. 26

Example for a too high magnification (Saturn).

What is "magnification"?

The magnification at which a telescope works is determined by two factors: The focal length of the telescope and the focal length of the eyepiece currently in use.

The focal length of a telescope determines the magnification. Lens telescopes are usually as long as the focal length. With the mirror-lens combination of an MCX model, however, this focal length is ultimately extended by the telescope's secondary mirror so that a long effective focal length can be accommodated in the MCX's short telescope tube. The focal length of the MCX-127, for example, is 1900 mm. If you had a classic refractor in front of you, it would mean that its optical tube would have to be more than 1.9 m long - thus considerably longer than the handy MCX tube length of almost 40 cm with the MCX-127!

The eyepiece focal length stands for the distance the light travels in the eyepiece until it reaches the focal point. The focal length of the eyepiece is usually indicated on the side of the eyepiece. The Super Plössl (SP) 26mm eyepiece supplied with the MCX has a focal length of 26mm. The term "Super Plössl" here stands for the optical design of the eyepiece, a design specially designed for high-performance telescopes that provides a large, comfortable field of view combined with extremely high image resolution.

Calculation of the magnification: A telescope uses different eyepiece focal lengths to achieve different magnifications. The SP 26mm eyepiece, which is part of the standard equipment, produces a 73x magnification (73x) with the MCX-127, for example. If you equip yourself with additional eyepieces from the range of accessories, you will get a wide variety of magnification options. In addition, you can double the magnification of the eyepieces used with a 2x Barlow lens (see also "Optional accessories" on page 36).

To calculate the magnification you can achieve with a given eyepiece, use the following formula:

Telescope focal length

V

Basic knowledge

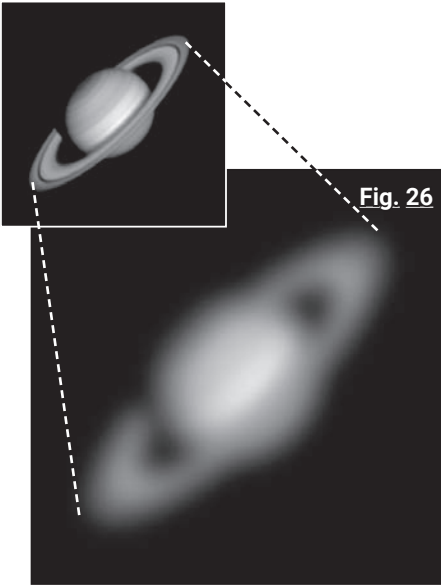

Example for a too high magnification (Saturn).

$$\text{Magnification} = \frac{\text{Objective focal length}}{\text{Eyepiece focal length}}$$

Example:

The magnification achieved by the MCX-127 in conjunction with the SP 26mm eyepiece is as follows:

$$\text{Magnification} = \frac{1900 \text{ mm}}{26 \text{ mm}} = 73x$$

Too much magnification: The most common mistake an inexperienced observer makes is to "over-zoom" the telescope - he uses too high magnifications that no longer match the telescope aperture and typical atmospheric conditions. Never forget that a smaller, but bright and well-resolved image is far superior to a larger image, which appears to be flat and poorly-resolved! See in this context the figure. 9 on. Magnifications beyond 250x should only be used when atmospheric conditions are exceptionally stable.

Most observers should have three or four eyepieces and a 2x Barlow lens to take advantage of the full range of meaningful magnifications possible with the MCX.

Telescope mounts

The technical aids which ensure that the optical tube of a telescope can be moved in different directions are summarised under the term "telescope mount" or "mount". These telescopic mountings can be divided into two basic designs:

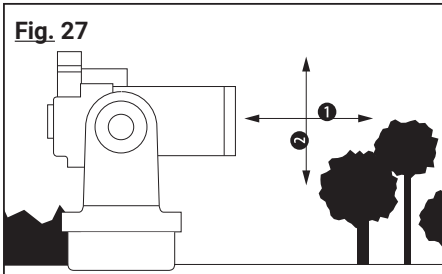

Fig. 27
The azimuthal mount moves the telescope vertically and horizontally. (1 = Azimuth; 2 = Height (Elevation))

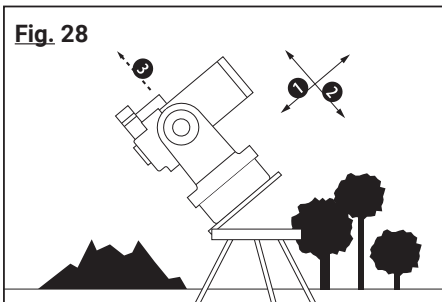

Fig. 28
The equatorial mount is aligned with the celestial pole. (1 = right ascension; 2 = declination; 3 = polar star)

Azimuth mounts allow the telescope tube to move vertically and horizontally. The MCX has an azimuthal mount (fig. 27). In this azimuthal configuration, the telescope is ideally suited for all terrestrial applications and for occasional astronomical observations. For this purpose, you may place the telescope on a fixed table top without further ado. Of course, the field tripod supplied as standard is recommended as a safe, height-adjustable, azimuthal observation foundation. To adjust and manually track various objects - whether terrestrial or astronomical - with the telescope mounted in the azimuthal configuration, the observer simply presses the arrow keys of the handheld computer (5, fig. 25; page 34).

Automatic tracking in both axes is only possible after successful 1-star, 2-star or 3-star alignment (see pages 24 and 25).

Equatorial (parallactic) mounts are exceptionally advantageous when a telescope is to be used for extensive astronomical applications, as the celestial objects move neither horizontally nor vertically, but follow a combination of these two directions of motion. If you use one of the mechanical telescopic axes (see Fig. 28) tilts until it points to the celestial pole (i.e. by aligning this telescope axis with the polar star), astronomical objects can be tracked by moving only this axis of the telescope. With the azimuthal mount, both axes must be moved simultaneously instead. An equatorial mount in which one of its axes (the so-called polar axis) points to the celestial pole is called "aligned with the pole". You can align the MCX to the terminal. Use the supplied field tripod with pole height cradle.

Once you have aligned the MCX with the pole, follow the instructions on page 19 (Aligning the MCX with the Sky Pole). This enables you to track celestial objects particularly evenly. In this configuration, the observer no longer has to press the arrow keys of the handheld computer to track the celestial objects. Independent of the automatic tracking, the arrow keys of the Autostar are very helpful in this configuration when it comes to centering objects in the center of the telescope's field of view, or if you want to wander over the lunar surface with the telescope, for example, or wander through a larger star field.

The handheld: The handheld computer allows you to operate your MCX with either the azimuthal or equatorial mount. The azimuthal mount is superior to the equatorial mount in terms of stiffness and stability, but has the disadvantage that the tracking of astronomical objects is less accurate. The handheld computer of the MCX compensates for this as far as possible with computer-controlled tracking - this combines the advantages of both mounting types, but avoids the disadvantages! In astrophotography, however, the equatorial mount should be preferred due to the rotation of the image field. In addition, the handheld computer has the option of automatically approaching astronomical objects.

Terrestrial Observations

The high-resolution MCX is both an astronomical and a terrestrial telescope. If you use the telescope as shown in Fig. 27, then you can use it for an extremely comprehensive range of observations. Never forget, however, that the terrestrial images may be upright, but are displayed in reverse as soon as you look through the eyepiece. Normally this image orientation is not too annoying, unless you want to read a remote license plate or similar.

The observation of terrestrial objects requires a viewing direction along the earth's surface through heat streaks. These heat streaks often cause serious losses in image quality. Low magnification eyepieces, such as the SP 26mm eyepiece, enhance the effect of these streaks less than eyepieces with higher magnifications. For this reason, weaker magnifying eyepieces provide a smoother image with higher image quality. If the image appears blurry or poorly defined, downgrade to a lower magnification where the heat streaks will not have such a devastating effect on the image quality. Observation during the early morning hours, before a heat accumulation has formed on the ground, usually offers better visibility conditions than during the late afternoon hours.

Astronomical Observations

Once used as an astronomical instrument, the MCX offers numerous optical and electromechanical capabilities. And especially in these astronomical applications, the extraordinarily high degree of optical performance of the MCX is apparent at first glance. The abundance of observable astronomical objects, with less experience, is limited solely by the motivation of the observer.

 **RISK OF BLINDNESS!**

Never use an MCX Astro Telescope or Viewfinder to look into the sun! A look into the sun or in its rough direction causes immediate and incurable damage to your eye. Damage to the eye is usually painless, so there is no warning for the observer when damage has occurred - only when it is too late does the accident reveal itself! Do not point the telescope or its search telescope up or next to the sun at any time. Never look through the telescope or search telescope when the instrument is moving. During observation, children must always remain under adult supervision.

Sidereal tracking speed

While the earth turns under the night sky, the stars seem to wander from east to west. The speed with which the stars move along is called "sidereal speed".

If the telescope is aligned with the celestial pole (see previous chapter "Telescope mounts" on page 15), the motor drive of the MCX is designed so that the telescope rotates at sidereal speed. In this way it automatically tracks the stars. This tracking facilitates the adjustment of objects and holds them - once adjusted - in the middle of the telescope eyepiece.

Rotation speeds

The handheld computer offers a total of nine rotational speeds, which are directly proportional to the sidereal speed. They have been designed so that the special functions can be carried out accordingly. Press a number key to change the rotation speed. It then appears on the display of the handheld computer for about two seconds.

The nine available speeds are as follows:

Number key 1 = 1x = 1x sidereal (0.25 arc minutes per second or 0.004°/sec)

Number key 2 = 2x ≡ 2x sidereal (0.5 arc minutes per second or 0.008°/sec)

Number key 3 = 8x ≡ 8x sidereal (2 arc minutes per second or 0,033°/sec)

Number key 4 = 16x ≡ 16x sidereal (4 arc minutes per second or 0.067°/sec)

Number key 5 = 64x ≡ 64x sidereal (16 arc minutes per second or 0.27°/sec)

Number key 6 = 128x ≡ 32 arc minutes per second or 0.5°/sec

Number key 7 = 256x ≡ 90 arc minutes per second or 1.0°/sec

Number key 8 = 512x ≡ 180 arc minutes per second or 2.0°/sec

Number key 9 = Max. ≡ 768 arc minutes per second or 3.0°/sec

Speeds 1, 2 or 3: Ideal for fine-tuning an object into the field of view of a higher magnification eyepiece, such as a 12mm or 9mm eyepiece.

Speeds 4, 5 or 6: For placing an object in the center of a low or moderate magnification eyepiece, such as the standard Super Plössl 26mm.

Speeds 7 or 8: Best suited for rough adjustment of an object.

Speed 9: This allows the telescope to move quickly from one place in the sky to another.

Fig. 29



Start position for equatorial/parallactic mounting of the MCX on a tripod. (1 = Polar star; 2 = Clamping height axis; S = Alignment to south)

Astronomical Observations

For extended astronomical observations, it is best to mount the telescope in the equatorial configuration. When aligned to the celestial pole, the telescope is oriented so that the horizontal and vertical axes of the telescope coincide with the coordinate system in the sky (see figure). 28 on page 15).

! NOTE!

For equatorial (parallactic) alignment, it is essential that the interface field is located to the right of the pole height adjustment (3, fig. 29) is located.

If you want to point the MCX at the celestial pole, it is essential that you develop an understanding of how and where a cosmic object can be located as it moves through the sky. This section introduces you to the basics of astronomy and includes instructions for finding the celestial pole. You will also learn about tracking objects in the night sky, familiarizing yourself with the terms "right ascension" and "declination".

Azimuth mode: The tripod head is clamped at 90°.

Equatorial mode: The tripod head is clamped to the geographical latitude angle of the observer.

Celestial coordinates

All cosmic objects are mapped with a coordinate system on the celestial sphere (fig. 30). This celestial sphere is regarded as an imaginary sphere that surrounds the entire earth and to which all the stars seem to be attached. The celestial mapping system corresponds to the earthbound coordinate system of longitudes and latitudes, simply projected onto the imaginary celestial sphere.

The two poles of the celestial coordinate system are defined as the two points at which the Earth's axis of rotation in its infinitely wide, fictitious extension to the north and south penetrates the celestial sphere. In this way the northern celestial pole is located (Fig. 30) exactly at the point of the sky where the extension of the earth's axis beyond the North Pole intersects the celestial sphere.

When mapping the earth's surface, the lines of longitude are drawn from the North Pole to the South Pole. Similarly, the latitudes are drawn as lines in an east-west direction, parallel to the earth equator. The celestial equator (Fig. 31) represents the projection of the earth equator to the celestial sphere.

Fig. 30

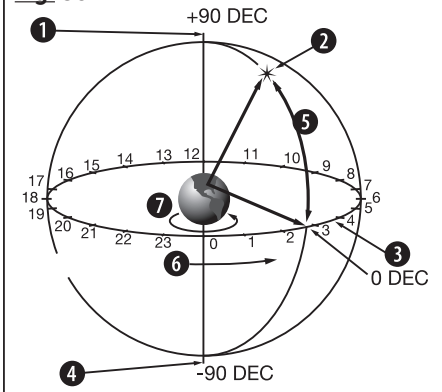

The celestial sphere. (1 = Northern celestial pole (not far from the polar star); 2 = Star; 3 = Celestial equator; 4 = Southern celestial pole; 5 = Declination; 6 = Right ascension; 7 = Earth rotation)

The mapping of the celestial sphere is done in the same way as on the earth's surface: One describes imaginary lines, which together form a coordinate net. In this way, the position of an object on the earth's surface can be determined by its length and width. For example, you can determine the position of the city of Los Angeles in California by its latitude (+34°) and westerly longitude. Describe length (118°). Similarly, the constellation of the Great Bear (which contains the Great Dipper) can be determined by its coarse position on the celestial sphere:

RA = 11h; DEC = +50°

- **Right ascension:** The heavenly equivalent of the earthly longitudes is called "right ascension" or "RA", it is given in the time scale of a 24-hour "clock". It indicates the distance measured in hours (h), minutes (m) and seconds (s) to an arbitrary "zero line" (RA 0h) passing through the constellation Pegasus. The coordinates of the right ascension run from 00h 00m 00s to 23h 59m 59s. In this way, there are 24 main RA lines that run vertically through the celestial equator at 15° intervals. Objects that are increasingly further east of the RA reference line (00h 00m 00s) carry increasing RA coordinate values.

- **Declination:** The celestial equivalent of the earthly latitudes is called "declination" or "DEC", it is given in degrees of angle, minutes of arc and seconds of arc (e.g. 15°27'33"). A declination running north of the celestial equator is marked with a "+" sign in front of the corresponding angular value (the declination of the northern celestial pole, for example, is +90°). Declinations south of the celestial equator are marked with a "-" sign (the declination of the southern celestial pole is e.g. -90°). Every point that lies on the celestial equator itself - which, by the way, runs through the constellations Orion, Virgo and Aquarius - has a declination of zero - this is indicated as "00°00'00".

VI

Alignment and Orientation

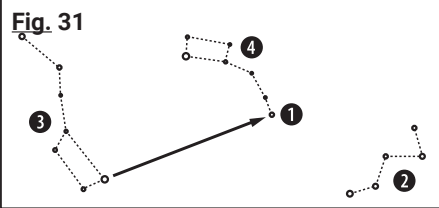

Search map for the Polarstern.
(1 = Polar star; 2 = Cassiopeia; 3 = Big car; 4 = Small car)

All objects of the sky can thus be precisely defined by their celestial coordinates in right ascension and declination.

Finding the celestial pole

To get a rough idea of where the points of the compass are at an observation site, you should be aware of the directions where the sun rises (east) and sets (west) every day. After it has become dark at your place of observation, turn north - you achieve this by pointing with your left shoulder in the direction where the sun went down earlier. In order to find the pole exactly, you should now locate the polar star - use the Big Dipper as the leading star image for this purpose (fig. 31).

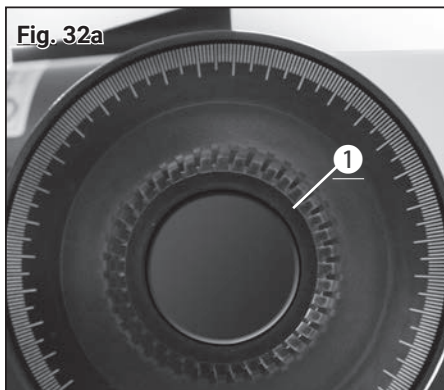

Release the clamping of the height axis.

Alignment of the MCX to the celestial pole

While the earth rotates once around its axis in about 24 hours, all astronomical objects seem to wander on arcs across the sky. This apparent movement (see "sidereal speed" on page 19) is hardly noticeable to the unaided eye. But when viewed through a powerful telescope like the MCX, it does indeed appear very quickly. If the motor-driven tracking was not activated, an object that was just visible in the middle of the telescope eyepiece disappears completely from view within a few seconds.

For a comfortable tracking of astronomical objects you should align your MCX telescope to the celestial pole.

1. Make sure that the telescopic sight is adjusted with respect to the ETX main tube (see "The LED Viewfinder" on page 10).
2. Determine the geographical latitude of your observation location from a road map or an atlas. The determination of the geographical latitude to the nearest degree is completely sufficient.
3. Loosen the locking screw for the scale stick (3, fig. 29) and adjust the required pole height by adjusting the tilt plate. Then tighten the locking screw again.
4. Bring the MCX telescope into the starting position (Fig. 29).

! NOTE!

The following steps 5 and 6 are absolutely necessary to prevent the telescope from moving against the mechanical stops during automatic initialization and to prevent damage to the drive motors.

5. Release the axis clamping of the horizontal clamping (right ascension clamping) (9, fig. 2) and carefully turn the telescope mount manually counterclockwise until the mechanical stop is reached.
6. Turn the telescope mount back to its starting position (Fig. 29) and tighten the axle clamp by hand.
7. Release the clamp of the vertical axis (1, fig. 32a) on the right fork arm and move the tube to the zero degree position (2, fig. 32b - Pitch circle scale on the left fork arm).

! NOTE!

For a fast observation in parallactic mode the adjustment of the pole height and the height axis by scale and pitch circle is completely sufficient. To achieve even more precise positioning and tracking, we recommend optimizing the start position (see "Optimized start position" on page 20)

8. Initialize the handheld computer.
9. Select a predefined observation location or enter a user-defined location (see "Initializing the controller" on page 24).
10. In the main menu "Settings", select the menu item "Tracking mode" and set "EQ Telescope".



Zero position

11. Select and execute the appropriate alignment method (see page 24).

Optimized start position

1. Adjust the pole height on the tilting plate of the tripod as accurately as possible using a scale.
2. Release the clamp of the height axis and set the scale to exactly 90° degrees and then tighten the clamp again slightly.
3. Turn on the LED viewfinder.
4. Move the complete tripod until you can see the polar star centered in the viewfinder. The telescope then moves towards the sky in the direction of the polar star. The aim is to align the right ascension axis of the telescope and the rotation axis of the Earth as parallel as possible. The following steps are required to do this.
5. Release the clamp on the right ascension axis. Slowly rotate the telescope by hand around this axis and simultaneously observe the movement of the target point on the mirror surface of the LED viewfinder. This will describe a circular path during rotation.
6. Now adjust the pole height adjustment of the tripod and the height axis of the telescope alternately and in very small steps. Observe exactly the change of the circular path achieved in this way. This should be as small as possible. The smaller the circular path of the target point, the more accurate the starting position.
7. Once the best possible setting has been found, set the height axis to exactly 0° using the scale and tighten the clamp firmly.
8. Slowly rotate the right ascension axis counterclockwise by hand until it reaches the mechanical end stop.
9. Rotate the right ascension axis back again until the telescope opening points exactly south and tighten the clamp firmly again.
10. Initialize the handheld computer.
11. Select a predefined observation location or enter a user-defined location (see "Initializing the controller" on page 24).
12. In the main menu "Settings", select the menu item "Tracking mode" and set "EQ Telescope".
13. Select and execute the appropriate alignment method (see page 24).

The handheld computer

1. LCD display
2. ENTER key
3. MODE button
4. key + key
5. Arrow keys
6. Numeric keys
7. Stop button
8. Help button
9. Connection socket for the spiral cable
10. Function key
11. Illumination button for the Taschenlampe
12. Torch
13. RS-232 interface*

*not active on these models, as no suitable accessories currently available

Fig. 33



Properties of the handheld computer

1. The eight-line LCD display (1, fig. 33) - It acts as an interface between the handheld computer and the telescope.

Various values/information or individual menu options of the menu structure are displayed to enable operation.

2. ENTER key (2, fig. 33) - It allows access to the next menu or to the next level of basic data in a given order.

3. MODE button (3, fig. 33) - Switches back to the previous menu or to the previous level of the menu. If you press it repeatedly, you will finally reach the top level "Select point". The MODE button is similar to the ESCAPE button of a computer.

4. + key (3, fig. 33) - Here you can recall the last objects accessed via DeepL access. To select an observation object, use the direction keys and press ENTER. The telescope control then positions the selected object in the field of view. It may happen that the object does not appear in the center of the field of view after positioning. In this case, center the object with the direction keys.

5. Arrow keys (5, fig. 33) - You rotate the telescope using nine different speeds in a specific direction (up, down, left and right). The preselection of the speed is explained in section "Rotation speeds" on page 9. The following functions are additionally made possible by the arrow keys:

- Data Entry - Use the up and down keys to scroll through the letters of the alphabet or through the sequence of numeric digits. The "down" key starts with the letter "A", the "up" key starts with the number "9". Use the Left and Right buttons to move the blinking cursor left or right in the LCD display.
- RA/Dec Alignment - Use the "Right" and "Left" buttons to rotate the telescope in the hour axis. The "Up" and "Down" buttons move the telescope in declination.
- Within a preselected menu, these keys allow access to various options of the database. The options in this menu appear one after the other in the second line, and when you press the up and down buttons, you move through the dif-

ferent options. You can also use the "Up" and "Down" keys to scroll through the letters of the alphabet or numeric digits.

! NOTE!

In case of a malfunction of the tracking system, please press the Stop button 2 times !

6. Numeric keys (6, fig. 33) - Here you can enter the numbers 0 - 9 and change the rotation speed (for more information see "Rotation speeds") The "0" button can also be used to switch the red flashlight on the top of the handheld computer on and off.

7. Stop button (7, fig. 33) - This interrupts any motor movement of the telescope. After pressing the button again, the telescope resumes the last executed function.

8. Help key (8, fig. 33) - It gives you access to the help function. Once your questions have been adequately answered by the Help function, press the MODE button to return to the original display. Continue with the previously selected procedure.

9. Connection socket for the spiral cable (9, fig. 33) - Plug one end of the spiral cable of the handheld computer into this socket (9, fig. 33). The socket is located on the underside of the handheld computer.

! NOTE!

To remove the spiral cable, first slightly press down the spring tab on the plug and only then pull the plug out of the connection socket of the hand box or the interface field of the telescope!

10. Function key (10, fig. 33) - Use this button to select an appropriate memory bank, e.g. from a previously programmed target object.

11. Illumination button for the flashlight (11, fig. 33) - Switches the flashlight (12, fig. 34) by pressing several times in two brightness levels on and off again.

12. Flashlight (12, fig. 33) - With this built-in red flashlight, you can illuminate star charts and accessories without losing the dark adjustment of your eyes.

13. RS-232 interface (11, fig. 33) - Not active on these models as there are currently no suitable accessories available Never try to connect an unapproved PC connection cable to this interface. This can lead to serious damage to the electronics!

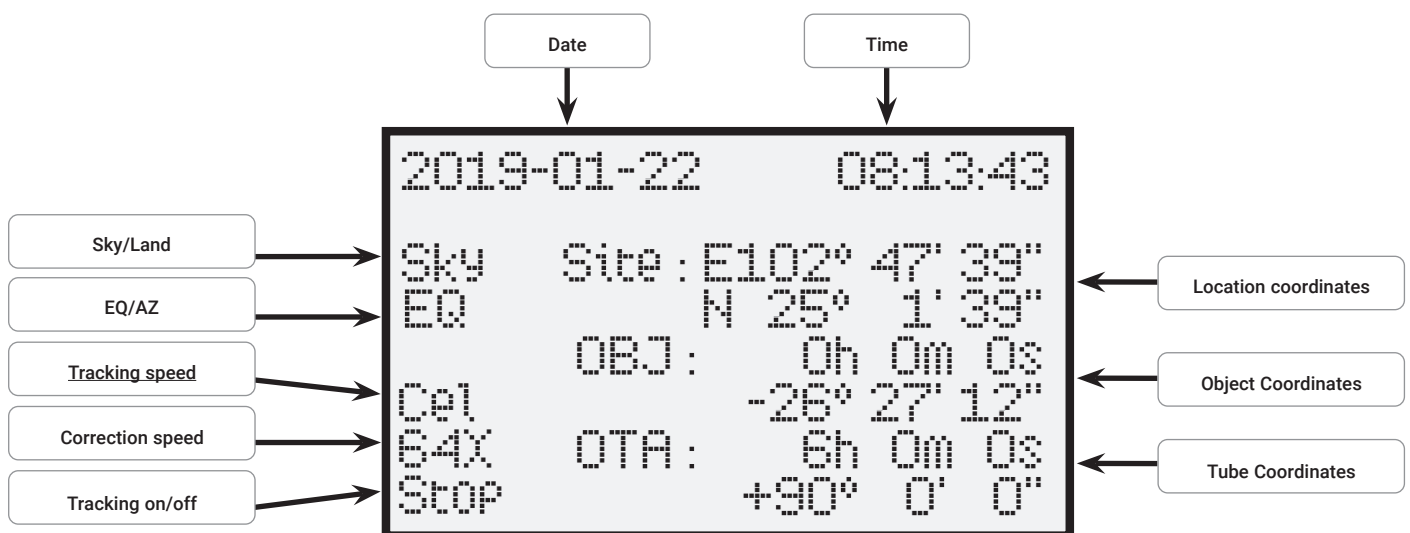

Fig. 34: The display of the handheld computer

Telescope control main menu

- Alignment

- one star Aim telescope at a star
- two-star Align telescope to two stars
- three-star Align telescope to three stars
- dubbing Increases alignment accuracy
- RA Spielausgl. RA Backlash compensation calibration
- DEC Playausgl. DEC Backlash compensation calibration

- Navigation

- solar system Object Catalog of the Solar System
- constellations Constellations Catalog
- Bright stars Catalog with known stars
- Messier Objects Catalog with bright Deep Sky objects
- NGC Objects Comprehensive catalogue with wide variety
- IC Objects Catalogue with weak objects
- Sh2 Objects Catalogue with weak objects
- Bright Star Objects Catalogue with bright stars
- SAO Objects Comprehensive star catalogue
- User Objects Allows you to save your own objects
- Enter coordinate Set your own point in the sky
- land objects Set your own point on the land

- Accessories

- Current events Currently visible objects
- rise and fall Rise and descent time of an object
- moon phase The current moon phase
- time Timer functionality
- alarm Set alarm
- Eyepiece FOV Field of view of the eyepiece
- Eyepiece Vergr. Enlargement of the eyepiece
- lighting Screen brightness
- Telescope parking Swivel to parking position

- Settings

- Date/Time Setting the date and time
- Summer/Winter Setting daylight saving time on or off
- Location Set the current location
 - Country & City Select the location from the database
 - Custom Site Enter the location via GPS data
- Astronomy./Terrestrial. Switch between sky and land line
 - Sky Target Setting for sky observation
 - Country Target Setting for land observation
- Tracking mode Switching between azimuthal and equatorial mounts
 - Alt Telescope Alt./AZ mounting
 - Eq Telescope EQ mount
- Mounting Telescope mount settings
- Tracking velocity Setting the tracking speed
 - Star Speed
 - Solar Speed
 - Moon Speed
 - Customize Speed
 - Guiding Speed Guiding Speed
- Language Select language
- Telescope Model
- Reset Reset to factory setting

Initialization of the controller

This chapter describes how to initialize the handheld computer. Perform this procedure either when you are using the handheld for the first time or when you have previously performed the RESET function (see "Resetting" on page 32).

1. Make sure that the DEC and RA clamps (6 and 9, fig. 2) are tightened according to the instructions.
2. Make sure the controls and power supply are properly connected to your telescope.
3. Set the power supply switch to "ON". The display field is activated, followed by a brief copyright message. A short beep will be heard. The controller now needs a moment to power up the system.
4. You will then be prompted to enter the date and time. The date is displayed in the format "Year-Month-Day / e.g.: 2016-31-12" is entered. The time is displayed in the format "Hour-Minute-Second / e.g.: 20:15:00" is entered. To do this, use the arrow keys and confirm your entries with the ENTER key (2 and 5, fig. 33).
5. You will now be prompted to enter daylight saving time. Select the "on" setting when using the telescope in daylight saving time. Select the "off" setting when using the telescope outside daylight saving time.
6. The next display will ask you about the country and city of your observation site. You have two different input options.
 1. You can select a city near you from the internal database (select "Country & City"). The countries are listed in alphabetical order in the database. Use the up and down direction keys to scroll through the list of countries and cities. When the desired city appears on the display, press the ENTER button.
 2. If you enter the data manually (select "Custom Site"), you can specify your location data manually. Enter the name ("Name"), the longitude ("Lon"), the latitude ("Lat") and the time zone ("Zone") and confirm your entries with the ENTER key.

Example: Name: Berlin ; Lon: E013° 25' ; Lat: N52° 30' ; Zone: E01

The telescope control now displays the main screen and is ready to align with the starry sky.



Fig. 29



One-star alignment

After you have completed the initialization, you can align the mount with the handheld computer. The fastest and easiest way to use control positioning is one-star alignment. The alignment can only take place at night.

1. Bring the telescope into the azimuthal position (Fig. 17) or parallactic home position (Fig. 29) and close the clamps in both axes. Please refer to the information in "Alignment of the MCX to the celestial pole" on page 19.
2. Press the ENTER button once to enter the main menu and select "Setup". Press the ENTER button and select "EQ" or "AZ".
3. Press the MODE button and select the menu item "Alignment". Press the ENTER button.
4. Various alignment methods now appear for selection. Select "One Star" and press the Enter key.
5. A selection of alignment stars is now displayed. Use the "Up" and "Down" direction keys to select the desired alignment star and confirm your selection with the ENTER key. The telescope now moves from the starting position to the vicinity of the selected alignment star.
6. It may happen that the star does not appear in the field of view of the telescope after positioning. Then use the direction keys to bring this star into the field of view and center it. The alignment star is usually clearly visible and the brightest star in the sky

! NOTE!

Once the telescope is aligned, move it using only the GoTo controls or the direction keys. Make the telescopic clamps (6 and 9, Fig. 2) now no longer on and also avoid having to manually adjust the base of the telescope. Otherwise the alignment of the telescope will be lost.

! NOTE!

The handheld calculates the best alignment stars based on location, time, and date. The stars can change from night to night and from hour to hour. As an observer, you only need to center the stars in your field of vision when prompted to do so.

region to which the telescope points. Once you have adjusted the viewfinder telescope, it will usually be the brightest star in the viewfinder's field of view. After the star is centered in the eyepiece field of view, press Enter. The successful alignment of the telescope is now confirmed with an acknowledgement tone.

After completion of the one-star alignment procedure, the motor drive runs for tracking. The telescope is now aligned for one night of observation. All objects should keep their position in the eyepiece, although the earth continues to rotate under the starry sky.

Two- and three-star alignment

The procedure is identical, but repeat steps 5 and 6 twice or three times for additional alignment stars.

Dubbing

This can be used to increase the accuracy of the positioning. After synchronization, the telescope compares the position of this object with the database. Sky objects in the immediate vicinity are then approached more precisely.

1. In the main menu "Alignment", select the menu item "Synchronization" and press ENTER.
2. "Targers Sync. open" is now displayed. Press ENTER.
3. "Synchronizing" is now blinkt in the display. Press ENTER.
4. In the main menu "Navigation", select e.g. the menu item "Messier objects" and select a visible object by pressing the ENTER key.
5. Press ENTER again and the telescope will move to the selected object. It could be that you still have to bring Saturn exactly into the center of the eyepiece with the direction keys. After this is done, press ENTER.
6. In the main menu "Alignment", select the menu item "Synchronization" again and press ENTER.
7. Select "Targers Sync. ensure" and press ENTER. Synchronisation is now complete and the position values on the LCD are recalculated and updated accordingly.

RA and DEC Backlash compensation

You can train the backlash correction of the axis for improved accuracy. This must be carried out separately for both axes and is usually not necessary. Press the central button (2) to enter the menu and select "Align". Then select "RA Spielausgl." or "RA Spielausgl." accordingly. "DEC Spielausgl."

1. Select the menu item "RA Game play" and press ENTER.
2. Insert a crosshair eyepiece into the eyepiece extension of the telescope.
3. Use the telescope to approach a high-contrast object (e.g. church spire) and center it as precisely as possible in the crosshairs. Press ENTER.
4. Briefly press the right direction button and wait until a control tone sounds.
5. Press and hold the left direction button until the previously set object is exactly in the starting position on the crosshairs. Press ENTER.
6. The measured value for the backlash of the RA motor in arc seconds is now displayed.

The "DEC Backlash Compensation" function works in the same way, except that the "Up and Down" keys must be used.

! NOTE!

At point 5, always approach the object from only one direction. It is not recommended to make corrections in the opposite direction in order to approach the object again. If necessary, the procedure must be aborted and restarted.

Navigation to the observation objects

"Go To Saturn"

This exercise shows you how to select a celestial object, Saturn, for observation from the basic data of your handheld computer.

! NOTE!

Note that the coordinates of Saturn (and other planets) change constantly over the course of a year. If the selected observation object (e.g. Saturn) is not visible below the horizon at the set observation time and location, this is indicated on the LCD with the message "Target under Horizon". In this case, press the MODE button once and select another object from the database.

1. After the telescope is aligned, the main screen appears on the LCD of the handheld computer. Press ENTER and you are in the main menu. Use the direction buttons to select "Navigation" and press ENTER.
2. You are in the submenu "Navigation" and various options of stored observation objects appear which can be approached with the help of the telescope control.
3. Select "Solar System" and press ENTER. Mercury" appears in the LCD. Use the "Up" and "Down" keys to scroll through the database until "Saturn" appears in the display. Press ENTER. The planet Saturn is now automatically approached by the telescope control. It could be that you still have to bring Saturn exactly into the center of the eyepiece with the direction keys.

The control moves the telescope automatically. This will "track" Saturn (or any other object you have just selected), that is, Saturn will remain permanently in the center of the eyepiece.

User objects

How to enter the coordinates of an object and approach the object under the "User object" option of the navigation menu:

! NOTE!

If the tracking was stopped by accidentally pressing the MODE button, the tracking can be switched on again by pressing the STOP button twice.

1. Make sure you have initialized the controls and aligned the telescope.
2. After aligning the telescope press the ENTER button to enter the main menu.
3. Select the Navigation menu option and press ENTER.
4. Select the "User Object" menu option and press ENTER.
5. Use the direction keys to select a memory location (F1 - F9) and press ENTER.
6. You can now enter the object name and coordinates in hours/minutes/seconds for the right ascension axis (Ra) and in degrees/minutes/seconds for the declination axis (DEC). Note the positive or negative sign of the degree. Save the entries with the ENTER key.
7. Press the MODE button twice to display the main screen.
8. Press the "F"-key (10, fig. 25) and select the desired memory location. Press ENTER. The telescope now moves to the previously stored object coordinates. The object is automatically tracked by the controller. After positioning, the object may not appear in the middle of the field of view of the telescope (eyepiece). Then center this object with the direction keys in the field of view.

Input of object coordinates

How to directly enter the coordinates of an object and move to the object under the "Enter coordinates" option of the navigation menu:

1. Make sure you have initialized the controls and aligned the telescope.
2. After aligning the telescope press the ENTER button to enter the main menu.
3. Select the Navigation menu option and press ENTER.
4. Select the "Enter Coordinate" menu option and press ENTER.
5. You can now enter the desired object coordinates in the format hours/minutes/seconds for the right ascension axis (Ra) and in degrees/minutes/seconds for the declination axis (DEC). Note the positive or negative sign of the degree.

6. Press ENTER. The telescope now moves to the previously stored object coordinates. The object is automatically tracked by the controller. After positioning, the object may not appear in the middle of the field of view of the telescope (eyepiece). Then center this object with the direction keys in the field of view.

Land objects

Unfortunately, this function is not yet available in the current software version!

Accessories menu

Here you can learn more about the additional functions of the telescope control.

Current events

Planets currently visible for your location with currently calculated rise and set times as well as the time of culmination (highest position in the south = best visibility) can be displayed here. Press the MODE button to return to the main menu.

! NOTE!

Make sure that the telescope controls have been successfully initialized beforehand.

Rise and fall times

If you would like to know the rise and fall times as well as the time of culmination (highest position in the south = best visibility) of any object with known coordinates for your location, you can calculate this under this menu item. Press the MODE button to return to the main menu.

! NOTE!

Make sure that the telescope controls have been successfully initialized beforehand.

Moon phase

The moon phases of the currently set month are graphically displayed here. The numbers indicate the tag belonging to the graphic. Use the arrow keys to change the year and month. This will immediately recalculate and display the moon phases. Press the MODE button to return to the main menu.

! NOTE!

Make sure that the telescope controls have been successfully initialized beforehand.

Time (Timer)

The timer function sounds a signal tone after an arbitrarily adjustable time in seconds. Thus, for example, exposure times in astrophotography can be maintained to the second. Enter the desired time in seconds and press ENTER to start the timer. Press the MODE button to return to the main menu.

Alarm

The alarm function sounds a signal tone at any time that can be set. So you can plan sky events to not miss them. To do this, enter the desired time in 24-hour format and press ENTER when the alarm is to be activated. Press the MODE button to return to the main menu. If you want to deactivate the alarm prematurely, select the menu item "Alarm" again and confirm "Close Alarm ?"

Eyepiece FOV (field of view)

The eyepiece FOV (Field of view) function can calculate the field of view of a particular eyepiece. After entering the focal length of the telescope used (MF), the focal length of the eyepiece (SF) and the apparent field of view of the eyepiece (E-FOV), press ENTER. The size of the field of view in degrees is then displayed in the lower line of the LCD.

Eyepiece Magnification

The Eyepiece Magnification function can calculate the magnification of a specific eyepiece. After entering the focal length of the telescope used (MF) and the focal length of the eyepiece (SF), press ENTER. The calculated magnification is then displayed in the bottom line of the LCD. Press the MODE button to return to the main menu.

! NOTE!

Make sure that the telescope controls have been successfully initialized beforehand.

LCD lighting

Select this function to adjust the backlight of the screen. Use the up and down buttons to select the appropriate lighting level. Press the MODE button to return to the main menu.

Telescope parking

Select this function to move the telescope to the parking position (start position). Switch off the telescopic control after reaching the parking position.

Settings

Here you can find more details about the adjustment possibilities of this telescope control.

Date and time

The date is displayed in the format "Year-Month-Day / e.g.: 2016-31-12" is entered. The time is displayed in the format "hour-minute-second / e.g.: 20:15:00" is entered. To do this, use the arrow keys and confirm your entries with the ENTER key.

Summertime / Wintertime

Select the setting (Daylight-saving) "on" when using the telescope in daylight saving time. Select the "off" setting when using the telescope outside daylight saving time.

! NOTE!

Ensure that this information is correct, otherwise deviations may occur during the calculations and the objects may not be approached exactly.

Location

Here you can set your observation location. You have two different input options:

1. You can select a city near you from the internal database (select "Country & City"). The countries are listed in alphabetical order in the database. Use the up and down direction keys to scroll through the list of countries and cities. When the desired city appears on the display, press the ENTER button.
2. If you enter the data manually (select "Custom Site"), you can specify your location data manually. Enter the name ("Name"), the longitude ("Lon"), the latitude ("Lat") and the time zone ("Zone") and confirm your entries with the ENTER key. An overview of the time zone can be found on page 30.

Example:

Name: London
Lon: W 0° 7' 39.929" ;
Lat: N51° 30' 26.464" ; Zone: W00

Time zone east of Greenwich:
E01-E12

Time zone west of Greenwich:
W01-W12

Greenwich time zone (GMT):
E00 or W00

Astronomical / Terrestrial

Unfortunately, this function is not yet available in the current software version!

Tracking mode

Allows you to choose between azimuthal and parallactic mode.

Mounting

Unfortunately, this function is not yet available in the current software version!

Tracking speed

Allows you to adjust the speed of the automatic tracking. Select the desired option and press ENTER. The following options can be set:

Star Speed: Sidereal velocity / star velocity
(default factory setting)

Solar Speed: Speed of the sun

Moon Speed: Moon speed

Customize Speed: Unfortunately, this function is not yet available with the current software version !

Guiding Speed: Unfortunately, this function is not yet available with the current software version !

Language

Select your preferred language. The following options are available: English , German , French , Italian , Spanish

Telescope Model

Unfortunately, this function is not yet available in the current software version!

Reset

This resets the telescope control to the factory settings. This is necessary if, for example, all personal settings are to be undone or if system errors occur. Then you have to reinitialize the telescope control and enter all user data again.

Fig. 36



How do I find the Polarstern?

Starting from the two "pointer stars" - the two rear stars of the car body - pull a fivefold extension up to the polar star. If you extend this line far beyond Polaris, you will reach the large square of stars shared by Pegasus and Andromeda.

The summer triangle is a striking sky region to the left of the Big Dipper drawbar. This triangle consists of three very bright stars: Vega, Deneb and Atair.

If you draw an imaginary line straight towards the car drawbar, you will come to the summer constellation of Scorpio. The scorpion bends in the sky like a scorpion tail to the left, it also looks a little like the letter "J".

The American amateurs coined the saying "Arc to Arcturus and spike to Spica", in German as much as "Bogen zum Arkturus und Spitze zur Spika". They thus refer to a region of the sky which lies in the direct extension of the arc which is described by the drawbar of the Great Dipper. Follow the arc to Arkturus, the brightest star in the northern hemisphere, and then "point" down to Spica, the 16th brightest star in the sky.

ASTRO-TIPP!

Star charts

Star atlases and rotating star maps are extremely useful and helpful utensils when it comes to planning an observation night. There are a large number of star atlases in book form, in magazines, on the Internet and on CD-ROM.

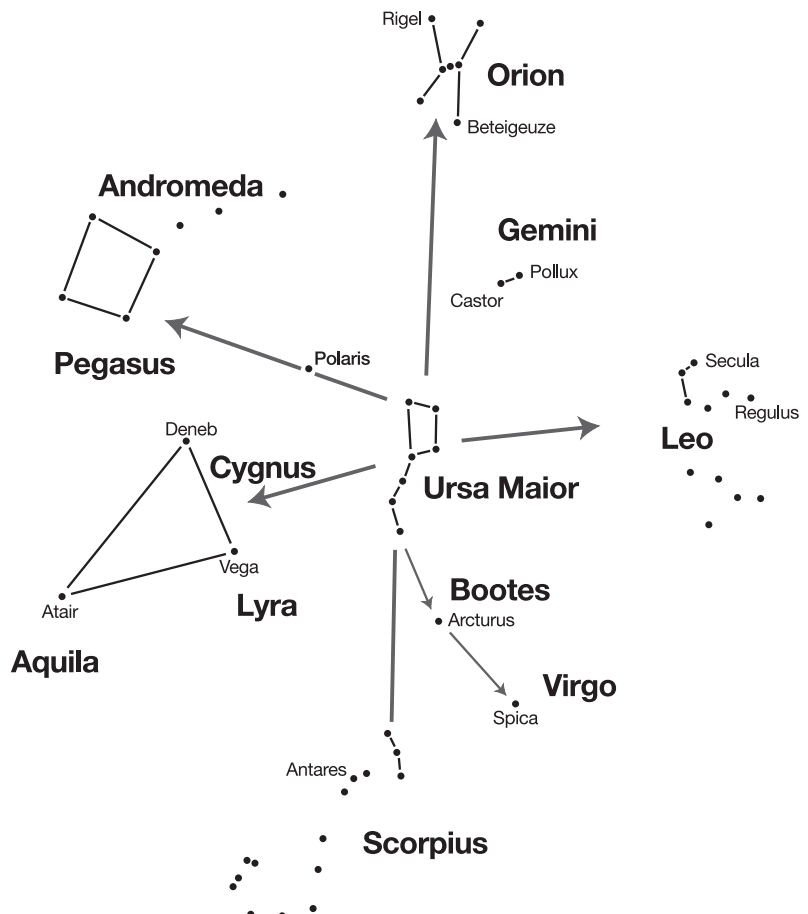

"You and the universe"

The distance between Earth and Moon



The distance between the planets

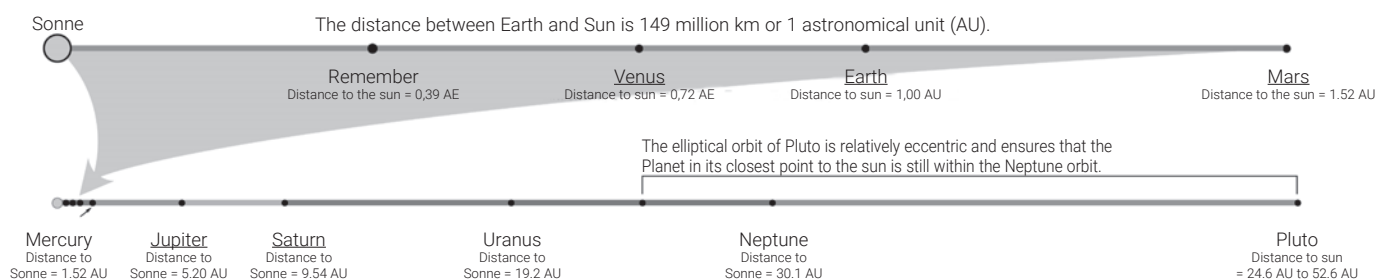

The distance between the stars

The distance from the sun to the nearest star is about 4.3 light years or about 40 trillion km. This distance is so great that in a model where the Earth would be 25 mm away from the Sun, the distance to the nearest star would be over 6.5 km!

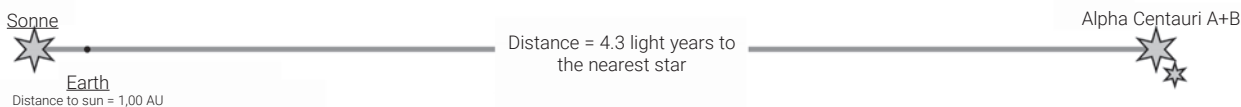

Our home galaxy, the Milky Way, together with our Sun, contains nearly 100 billion stars. It represents a spiral-shaped cluster of stars, presumably more than 100,000 light years in diameter.

The distance between the galaxies

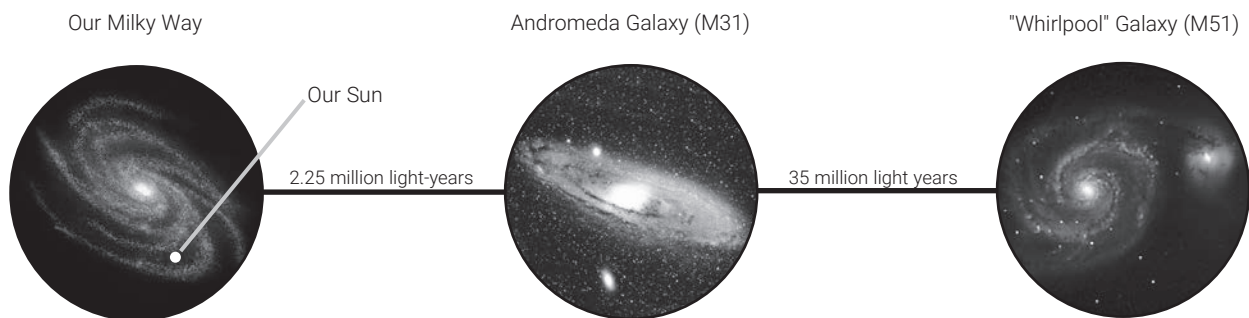

Observation

You should allow about 90 minutes for the temperature adjustment before observing. If the telescope is set up e.g. from a heated car or house on the free field, it can come to a so called "Tubus-Seeing". This results from the main mirror not yet adapted to the temperature difference.

Only after the temperature adjustment the telescope shows a sharp picture.

The first observations are best practiced during the day, so you will quickly become familiar with the operation of your new telescope.

First select a simple object: a mountain top, a lighthouse or the like. Roughly align the telescope to it.

Now target the target object with the light spot finder.

Now the object should already be visible in the 26mm eyepiece.

Now the image can be carefully focused with the eyepiece extension.

Now you can dare to go to the moon in the evening (if visible); the operation should be easy even in the dark. The phases that are increasing and decreasing are best suited for observing the moon, with their detailed shadow casts that allow crater formations and the like to emerge very vividly. During the full moon the surface appears relatively low-contrast and without structure.

For moon observation a neutral gray filter is recommended, which attenuates the partly bright light. This is available as an accessory from your specialist dealer.

Spend a few nights observing the moon; it is very interesting to see how individual formations such as mountains, craters and Mary change with changing phases of the moon!



The moon craters are good observation objects, especially for beginners.



The planet Venus during the sickle-shaped phase.

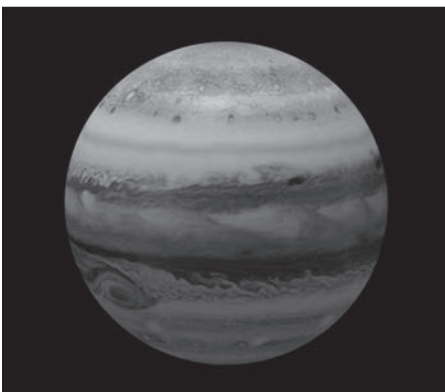

The four inner ("Galilean") moons of the planet Jupiter can be observed each night in a different position

Planets

On their way around the sun, the planets constantly change their position in the sky. Consult a monthly astro magazine (Interstellarum, Astronomy Today, Stars and Space) to find planets in the sky or search the Internet. In the following you will find a list of the planets which are particularly suitable for observation with the Messier telescope:

Venus

The diameter of Venus is about 9/10 of the diameter of the earth. While Venus orbits around the Sun, the observer can follow how it constantly changes its light phases: Sickle, half Venus, full Venus - very similar to what you are used to from the moon. The planet disk of Venus appears white, because the sunlight is reflected by a compact cloud cover that covers all surface details.

Mars

The diameter of Mars is about half the diameter of the earth. Mars appears in a telescope as a tiny, reddish-orange slice. There's a chance you might spot a touch of white when you look at one of the planet's two icy polar caps. Approximately every two years, additional details and color effects become visible on the planet's surface. This happens whenever Mars and Earth come closest to each other on their orbits.

Jupiter

The largest planet in our solar system is called Jupiter, its diameter is eleven times larger than the Earth. The planet appears as a disk over which dark lines extend. These lines are cloud bands in the atmosphere. Even at the lowest magnification, four of the 18 Jupiter moons (Io, Europa, Ganymed and Callisto) can be recognized as "star-shaped" light points. Because these moons orbit Jupiter, the number of visible moons may change over time.

Saturn

Saturn has nine times the earth diameter and appears as a small, round disc. His rings protrude from both sides of this disc. Galilei, who in 1610 was the first man to observe Saturn in a telescope, could not have foreseen that what he saw would be rings. He thought Saturn had "ears." Saturn's rings consist of billions of ice particles, their size probably ranging from the tiniest dust particle to the size of a dwelling house. The largest



Saturn is one of the most worthwhile objects of observation, at least within the solar system.

ring division within Saturn's rings, the so-called "Cassini division", can normally be seen in the telescope. Titan, the largest of Saturn's 62 moons, is also visible as a bright, star-shaped object not far from the planet. Under good visibility conditions, up to 6 Saturn moons can be observed in the telescope.

Deep sky objects

In order to find constellations, single stars or "deep sky objects", the use of a star chart is recommended. In the following, various examples of deep sky objects are listed:

The stars are huge gaseous objects that glow independently because they generate energy in their centre through nuclear fusion. Due to their enormous distance, all stars appear as needle-sharp points of light, regardless of the size of the telescope used.

The nebulae are extended interstellar gas clouds and dust clouds from which new stars are formed. The most impressive nebula is without question the Great Orion Nebula, a diffuse nebula that looks like a faint, fibrous, grey cloud. M42 is 1600 light-years away from Earth.

An open star cluster consists of a loose group of younger stars, all of which have only recently emerged from a single diffuse nebula. The Pleiades form an open star cluster at a distance of 410 light years. Several hundred stars can be observed in the telescope.

Constellations are two-dimensional, imaginary star patterns which ancient civilizations believed to be heavenly equivalents of objects, animals, humans or gods. These groups of stars are far too large to be seen in their entirety in a telescope. If you want to learn the constellations, start with a distinctive group of stars - for example, the Great Dipper in the constellation of the Great Bear. You will then use a star chart to help you decipher the other constellations.



M31, the Andromeda galaxy, is one of the easiest objects to find and observe on winter evenings.

The galaxies are gigantic clusters of stars, nebulae, and star clusters, all held together by their mutual gravity. They are mostly spirally shaped (this also applies to our Milky Way), but many galaxies can also look like elliptical or irregular light spots. The Andromeda galaxy (M31) is the closest spiral galaxy to us. The sight of this Milky Way system resembles that of a blurred fog spindle. At a distance of 2.2 million light years they are found in the constellation Andromeda. It stands halfway between the big "W" of Cassiopeia and the star square of Pegasus.

With increasing observation experience, you can also dedicate yourself to more sophisticated observation objects such as globular clusters, planetary nebulae or comets that appear from time to time.

The more objects you "spy", the more you will be able to estimate the observation conditions and determine which objects are worthwhile in this night. It also makes sense to record the observed objects and the viewing conditions in a notebook.

One of the best ways to capture what you have seen is by drawing. At the same time the sense for details and fine nuances is sharpened here. Many of the professional journals and internet forums for astronomy offer opportunities to exchange information with other amateur astronomers.

Internet resources such as www.astrotreff.de or www.vds-astro.de are well suited to deepening one's own knowledge and gaining new ideas. You will notice that as your experience increases, so does your enjoyment of your hobby!



The Pleiades are probably the most impressive open star cluster in the northern sky.

Some tips

You will have noticed that objects observed through the telescope appear upside down and upside down. This is the case with every astronomical telescope for physical reasons and does not play a role in stellar observation.

Due to the rotation of the earth, all celestial objects seem to move slowly through the visual field. To compensate for this movement, all you have to do is slowly and evenly adjust the telescope. The higher the magnification, the more practice is required in order to achieve uniform tracking.

To compensate, you can also place the object on the eastern edge of the visual field and then observe it at rest with the tube released as it slowly moves through the visual field. Once it has reached the western edge, it is briefly "pushed back" again.

Vibrations: Avoid touching the eyepiece during observation. This or the slight trembling of a hand leads to restless images. Avoid observation sites with ground vibrations if possible (e.g. near railway lines or construction sites)

Dark adaptation: Allow your eyes to get used to the darkness. This dark adaptation lasts about 15 to 20 minutes and starts anew after each - even short - light disturbance. Use a lamp with a red filter, e.g. to read maps or work on the telescope; weak red light hardly disturbs the dark adaptation of the eyes.

Observing through windows (whether open or closed) is very unfavourable. The light collected by the telescope must penetrate several layers of glass or air, which leads to considerable image disturbances.

Planets and other objects, when close to the horizon, are strongly influenced by air turbulence and extinction. Here it is always worthwhile to place the observation at a time when they are as high as possible in the sky. Switch to an eyepiece with a lower magnification when the image is flickering or cloudy. Choosing a magnification that is too high is a mistake that is very common in beginners.

Warm clothes: Even in summer it can get very cool on clear nights, especially in the mountains. Take warm clothes such as sweaters, caps, gloves, thicker socks etc. with you to the observation site - even on the most beautiful night, observing is no fun if you are cold!

Explore your observation site by light: It should be located away from roads and other light sources that would prevent dark adaptation. Fog can often form near water at night and the ground itself should be firm and relatively flat. You can also watch from the city, but consider if you have the opportunity to go to a place further away. Really good sky conditions often only exist about 50 km away from big cities or conurbations. There's an old astronomer's saying: "A dark sky cannot be replaced by anything but a darker sky!"

Further information: As already mentioned above, the Internet and specialist journals provide a wide range of information for every age group. Good literature can often be found in libraries and city libraries. Also look for astronomical associations in your area - events are usually announced in local newspapers. A comprehensive list of clubs and observatories can be found at www.astronomie.de/gad

IX

Maintenance and care

If the air humidity is high, the glass may fog up and moisture may form. This is not a defect! In this case, allow the device to acclimatise at room temperature for some time so that the residual humidity can be reduced.

Protect the device from dust and moisture! Keep it in the supplied bag or transport packaging. Remove batteries from the device if it is not to be used for a longer period of time!

Disconnect the device from the power source (remove batteries) before cleaning!

Clean the device only externally with a dry cloth. Do not use cleaning fluid to avoid damage to the electronics.

Remove dust on the main mirror only with a bellows or soft brush. Do not touch or wipe the mirror with your fingers in order to avoid damaging the mirror.



Technical data

Model	MCX-102	MCX-127
Optical design	Maksutov-Cassegrain	
Main mirror dia.	110 mm	138 mm
Free opening	102 mm	127 mm
Focal length	1470 mm	1900 mm
Opening ratio / Photogr. Orifice	f/14,4	f/14,9
Close range (approx.)	50 m	
Max. Resolution (in arc sec.)	1,1"	0,9"
Remuneration	MgF2 Multi-layer coating	
Stellar visual limit value (approx.)	12,1 mag	12,5 mag
Image scale	2,34'/mm	1,8'/mm
Practical maximum visual magnification (approx.)	200x	250x
Dimensions optical tube (diameter x length)	12,4 cm x 32,8 cm	14,6 cm x 36 cm
Shading of secondary mirror Diameter / %	32 mm / 9.3 %	39 mm / 9.4 %
Mounting	Double arm fork mount	
Pitch circle Diameter	RA = 19.5 cm; DEC = 9.5 cm	RA = 22,5 cm; DEC = 10,7 cm
Power supply	12V DC via 8x batteries, type AA or suitable power supply unit connection type: DC hollow plug 5.5/2.5 mm; polarity: ⊖ ● ⊕	
Propulsion system	DC servo motors with encoders in both axes	
Fine movement	electric, 9 speeds, in both axes	
Computerised Handbox with LED display	standard	
Earth hemispheres for observation	North and South, switchable	
Ball-bearings Elevation Azimut	Radial ball bearing Radial ball bearing	Radial ball bearing Radial ball bearing
Materials: Telescope tube Telescope mount Main mirror Correction lens	Die cast aluminium structure and ABS plastic housing Pyrex(R)-Glas BK-7 Optical glass, class A	
Dimensions telescope	43 cm x 25 cm x 20 cm	48 cm x 23 cm x 27 cm
Net weight telescope incl. hand computer and batteries	3,5 kg	8,5 kg
Shipping weight telescope	5,6 kg	12,4 kg
Battery life with handheld computer (approx.)	10 hours	

XI

Optional accessories



BRESSER Plössl eyepieces

f/5 mm
Item no. 4920205 (Ø 31.7mm, 1¼")
f/6,5 mm
Item no. 4920206 (Ø 31.7mm, 1¼")
f/10mm
Item no. 4920210 (Ø 31.7mm, 1¼")
f/15mm
Item no. 4920215 (Ø 31.7mm, 1¼")
f/20mm
Item no. 4920220 (Ø 31.7mm, 1¼")
f/25mm
Item no. 4920225 (Ø 31.7mm, 1¼")
f/30mm
Item no. 4920230 (Ø 31.7mm, 1¼")



BRESSER 12V power supply 2.0A

Item no. 0455121



BRESSER 12V Automotive Power Cable, 7.5m

Item no. 4930100



BRESSER Barlow lens 2x

Item no. 4950110
(Ø 31,7mm, 1¼")



BRESSER Upright prism 45° f. MCX-102/127

Item no. 4930220
(Ø 31,7mm, 1¼")



BRESSER Smartphone holder

Item no. 4910300

(without Smartphone)

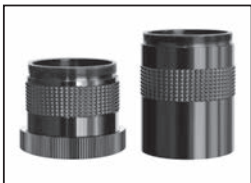

BRESSER camera adapter

Item no. 4940180



BRESSER Smartphone Adaptor Deluxe f. Telescopes

Item no. 4914914

(without smartphone and telescope)



BRESSER WiFi camera

Item no. 4959010
(Ø 31,7mm, 1¼")



BRESSER exchange protection cap f. MCX-102

Item no. 4930700



BRESSER exchange protection cap f. MCX-127

Item no. 4930710



BRESSER Full HD Deep-Sky Kamera & Guider

Item no. 4959050
(Ø 31,7mm, 1¼")



BRESSER Tripod Bag Deluxe f. MCX-102/127 Tripod

Item no. 4930600



BRESSER Full HD eyepiece camera

Item no. 59-13650
(Ø 31,7mm, 1¼")



BRESSER Deluxe Transport Case f. MCX-102/127

Item no. 4930500

This and other accessories
you will find on

www.bresser.de

XII

Disposal

 Dispose of the packaging materials by type. Observe the current legal regulations when disposing of the device! Information on proper disposal can be obtained from municipal waste disposal service providers or the Environmental Agency.

 Do not throw electrical appliances into the household waste!

According to the European Directive 2002/96/EC on Waste Electrical and Electronic Equipment and its transposition into national law, used electrical equipment must be collected separately and recycled in an environmentally sound manner.

 Batteries and rechargeable batteries must not be disposed of with household waste. You are legally obliged to return used batteries and accumulators and can return the batteries after use either in our sales outlet or in the immediate vicinity (e.g. in the trade or in municipal collection points) free of charge.

Batteries and accumulators are marked with a crossed-out dustbin and the chemical symbol of the pollutant, "Cd" stands for cadmium, "Hg" stands for mercury and "Pb" stands for lead.

XIII

Warranty & Service

The regular warranty period is 2 years and begins on the day of purchase. The full warranty terms and conditions as well as information on warranty extension and services can be found at www.bresser.de/garantiebedingungen.

XIV

CE Declaration of Conformity UKCA Declaration of Conformity

A "CE Declaration of Conformity" in accordance with the applicable directives and corresponding standards has been prepared by Bresser GmbH. This can be viewed under:

www.bresser.de/download/4701102/CE/4701102_CE.pdf
www.bresser.de/download/4701127/CE/4701127_CE.pdf

Bresser GmbH
Gutenbergstr. 2 · 46414 Rhede · Germany

Bresser UK Ltd. has issued a "UKCA Declaration of Conformity" in accordance with applicable guidelines and corresponding standards. This can be viewed under:

www.bresser.de/download/4701102/UKCA/4701102_UKCA.pdf
www.bresser.de/download/4701127/UKCA/4701127_UKCA.pdf

Bresser UK Ltd.
Suite 3G, Eden House · Enterprise Way
Edenbridge, Kent TN8 6HF · Great Britain



www.bresser.de/start/bresser



Bresser GmbH

Gutenbergstr. 2 · DE-46414 Rhede
Germany

www.bresser.de · service@bresser.de

Bresser UK Ltd.

Suite 3G, Eden House · Enterprise Way
Edenbridge, Kent TN8 6HF
Great Britain