

Vixen®

**POLARIE
Star Tracker
User's Guide**



PREFACE

Thank you very much for your purchase of a Vixen Polarie star tracker.

This manual describes the functions of the Polarie star tracker.

You may occasionally find descriptions in the text not relevant to your particular model; this depends on the model you purchased.

You should refer to the instruction manuals for your camera, ball head adapter, camera tripod and shutter release control together with this manual as occasion demands.

Read through this manual before use.

- Always keep the instruction manual near your Polarie to ensure quick answers to any questions.
- This instruction manual describes necessary precautions for the safe use of the product to prevent possible injuries to yourself and others, as well as damage to the equipment.

⚠ WARNING!

Never look directly at the sun with your naked eyes or through this product or its polar axis scope sold separately. Permanent and irreversible eye damage may result.

⊘ CAUTION

- ⊘ Do not use the product while traveling or walking, as injuries may arise from stumbling, falling or collision with objects.
- ⊘ Do not try to restrain the movement of the mount when in operation, which may lead to injuries to you or damage to your equipment.
- ⊘ Do not use the product in a wet environment
- ⊘ Do not turn on the power switch of the product under circumstances when internal condensation is suspected on the equipment. It may cause a failure by a short circuit.
- ⊘ Do not attempt to disassemble or alter any part of the equipment that is not expressly described in this manual.
- ⊘ Use only recommended power sources. Using other power sources could result in damage to the unit.
- ⊘ Insert the batteries in the correct direction.
- ⊘ Be careful not to drop the unit when handling. This may cause damage or lead to injury.

HANDLING AND STORAGE

- Do not leave the product inside a car in bright sunshine, or in hot place. Keep any strong heat radiation sources away from the product.
- Do not expose the product to rain, water drops, dirt or sand.
- When cleaning, do not use solvent such as paint thinners.
- For storage, keep the product in dry places, and do not expose to direct sunlight.
- Remove the batteries from the battery compartment if the product is not used for a long time.

CONTENTS

PREFACE P 2

- ⚠ Warning!..... P 2
- ⚠ CautionP 2
 - Handling and Storage P 2

CONTENTS P 3

BEFORE USE P 4

- Checking Contents P 4
- Basics of the Polaris P 4
- Parts DescriptionsP 5
- M-178V Tripod for Polaris P 6
- Mode Dial P 7
- Requirements and Useful Items P 8

PREPARATION P 10

- Batteries for the Polaris P10
- Inserting the Batteries.....P10
- Utilizing an External Power Supply..... P10

SETTING UP P11

- Setting up the Polaris..... P11

USING THE POLARIS P13

- Flow of Operation..... P13
- What is Polar Alignment?.....P13
- Using the Polaris in the Northern Hemisphere P14
 - 1. Find Polaris using a compass and the latitude of P14
 - your location
 - 2. Find Polaris from Cassiopeia and the Big Dipper P15
- Using the Polaris in the Southern HemisphereP16
 - 1. Find Octans using Small Magellanic Cloud and the Southern Cross (Crux) as pointersP17
 - 2. Find Octans using the arrangement of stars in the Southern Cross (Crux) as pointers.....P17
 - 3. Find Octans using Small Magellanic Cloud, Beta Hydrus and Gamma Octantis as pointers.....P17
- Point the Polaris to the South Celestial PoleP17
- Basic Camera SettingsP18
- Switching ON the Polaris.....P18
- Star-Scape Photography ModeP19
- Wide-Field Astrophotography ModeP20
- Solar Tracking Mode, Lunar Tracking ModeP20

SPECIFICATIONS P21

APPENDIX P23

- Using an optional Polaris Polar Axis Scope P23

BEFORE USE

The Polarie box contains the parts listed below. Make sure that your box contains all these parts.

Checking Contents

Polarie

Polarie User's Guide (This manual)

If purchased the Polarie as a package with the tripod

M-178V Tripod with QHD-43 Ball head

QHD-33 Ball head

BASICS OF THE POLARIE

Stars seem to rotate around the celestial poles of the earth. This is called the diurnal motion of stars. This is because Earth makes one rotation on its axis each day. Polarie tracks with the diurnal motion of the stars to eliminate "star trailing" on photographic images.

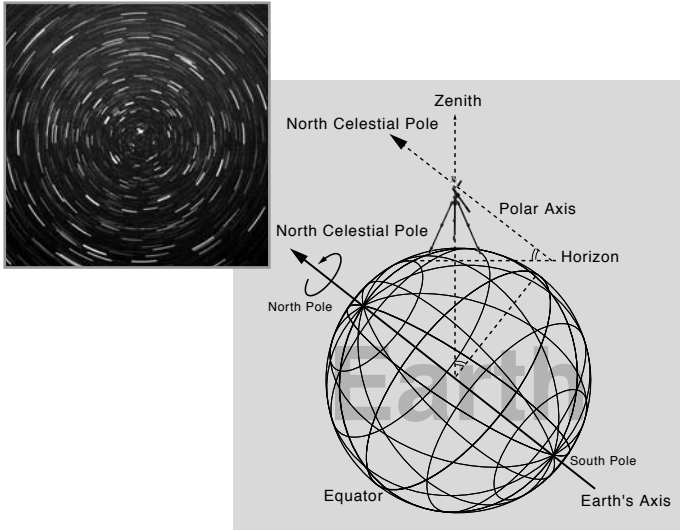

The motor-driven Polarie is set so that its rotational axis is parallel to the axis of the diurnal motion of stars. It allows you to track the camera, mounted on the Polarie, in the same direction as the stars you want to photograph.

The Polarie is a totally new photographic accessory which easily allows you to take pinpoint photos of stars and constellations. It is designed to follow the apparent motion of the stars caused by the earth's rotation, eliminating star trails.

With use of the Polarie, taking wide field photographic images of constellations, the Milky Way, shooting stars and bright comets is surprisingly simple and easy.

Polarie also enables you to photograph starry nightscapes by adding a night landscape or silhouetted figure in the foreground of your frame. We name it "Star-Scape" photography.

BEFORE USE

Parts Descriptions

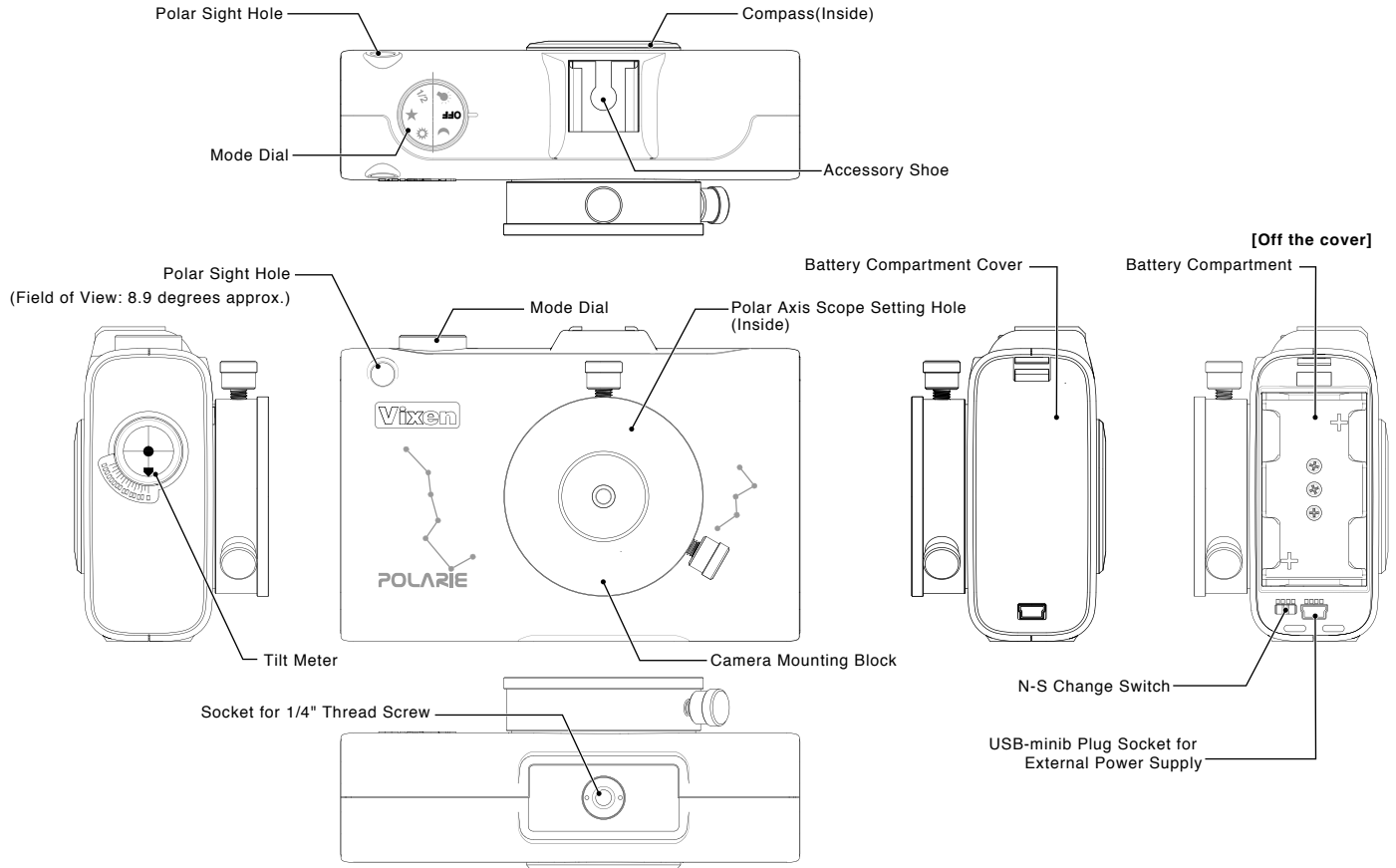

BEFORE USE

M-178V Tripod for Polarie (If purchased as a package)

Ball head adapter 1: QHD-43



Ball head adapter 2: QHD-33



BEFORE USE

Mode Dial

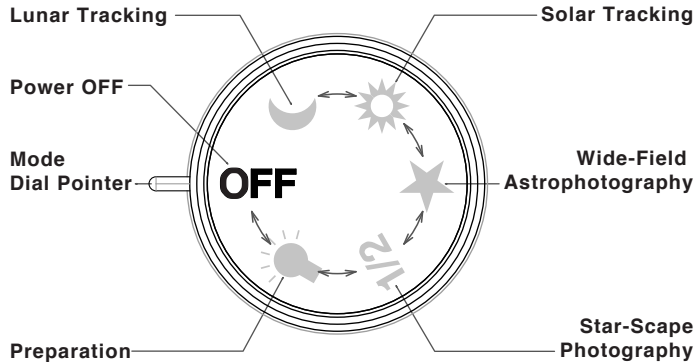

Color of the backlit legends on the mode dial is changed if the rotating direction of the tracking motor is switched.





Tracking in northern hemisphere : **Illuminated in red**

Tracking in southern hemisphere : **Illuminated in green**

Wide-Field astrophotography vs. Star-Scape photography

Wide-field astrophotography : Photographs of wide-field views of constellations and the Milky Way are called wide field photography. Usually nightscapes are not included in the frames of photographs but they will be in the background part of your image.

Star-Scape photography : Photographs of wide-field views of constellations and the Milky Way plus night landscapes under starry skies that are included in the frames of photographs.

Legend : Mode	Description
OFF : Power OFF	Shuts off the power of Polarie.
 : Preparation	Used for polar alignment(Set to be parallel to the axis of the diurnal motion.). The built-in tilt meter is backlit in red when the mode dial is set at this position.
1/2 : Star-Scape Photography	A half speed of the celestial tracking rate is selected for star-scape photography.
 : Wide-Field AstroPhotography	Celestial tracking rate is selected for wide-field astrophotography with no trailed stars.
 : Solar tracking	Drives Polarie at the mean solar time.
 : Lunar tracking	Drives Polarie at the mean lunar time.

Star-Scape Photography

The Polarie allows you to not only take pinpoint photos of stars and constellations but also to create “star-scape” photos in night-sky scenes by adding a motionless night landscape or silhouetted figure in the foreground of your frame.

BEFORE USE

Requirements and Useful Items

A table below shows necessary equipment and items that are useful for astro-photography with the Polarie.

Essential : ☉ **Needed subject to conditions :** ○ **Useful :** △

Need	Item	Description
☉	Polarie	Ultra-small and handy star tracker.
☉	2 x AA-size Batteries (Sold commercially)	Alkaline batteries or rechargeable Ni-MH or rechargeable Ni-Cd batteries are recommended. Battery performance decreases in cold weather. Be sure to prepare spare ones.
△	External Power Supply (Sold commercially)	Power supply with USB-output (USB-mini Type : DC4.4~5.25V) can be used . It is convenient for long exposure wide-field astrophotography.
☉	Camera Tripod (Sold commercially)	The tripod pan head with UNC1/4" thread is required. It is recommended to use a sturdy tripod. Included if purchased as a package.
☉	Ball Head Adapter (Sold commercially)	Used to mount your camera on the Polarie. Solid ball head type is recommended. Included if purchased as a package.
△	Polar Axis Scope (Optional)	It allows for a more accurate polar alignment.
☉	DSLR Camera with Lens(1) (Sold commercially)	A digital SLR camera with wide-angle lens is the most preferable. Remember to bring the battery for the camera and storage media (CF, SD and etc.)with you, also.
△	Lens Shade (Sold commercially)	It is useful to avoid unwanted stray light and lessen dew condensations on the lens surface of your camera.

Need	Item	Description
○	Shutter Release Cable(2) (Sold commercially)	It is used to avoid moving the camera and also to control shutter exposure times. Genuine parts are recommended.
△	Timer or Stopwatch	It is used to measure the shutter exposure times.
△	Weak Adhesive Tape (Sold commercially)	It is used to hold the position of the focusing ring after you focus the lens to the object. Autofocus lenses with inner focusing systems may not hold the focus.
△	Dew Heater (Sold commercially)	It is used to prevent the lens surface from dew condensing during the photography session.
△	Planisphere, Star Chart	It is useful to confirm the directions of constellations and the position of stars.
○	Red Flashlight	It is used to read star charts, setting up and dismantling equipment.
△	Outfit for cold weather,Repellant	Take precautions against the cold. Use an insect repellent if necessary.
△	Shroud, Plastic bags	It is useful to protect equipment from a sudden rain.

BEFORE USE

Requirements and Useful Items

(1) It is strongly recommended that your camera have functions that satisfy the following specifications.

- A bulb shutter mechanism is needed for long exposures. If it is not available on your camera, both an ISO speed setting faster than 3200 and a shutter exposure time setting longer than 30 seconds are required.
- Shutter release cables.
- Wide-angled photographic lenses are recommended.
- Manual Focus is available. Auto Focus rarely works in night-sky scenes.
- DSLR cameras with an optical viewfinder or “Live Focus” are preferable.

(2) It is best to use a remote release cable with functions to preset the shutter exposure times. Infrared wireless release models are not recommended.

PREPARATION

Batteries for the Polarie

Polarie works with 2 AA alkaline batteries which are sold separately. An external power supply is available for the Polarie using the USB-minib plug (DC4.4V to 5.25V)*.

*Sanyo Lithium Ion batteries with USB output (Eneloop KBC-L2B) is approved for use with Polarie as of Nov. 2011.

Inserting the Batteries

- 1 Open the battery compartment cover by pushing down on the tab of the cover as shown.
- 2 Insert two AA alkaline batteries in the correct direction.

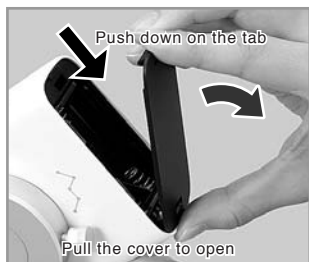

- 3 Confirm the N-S change switch inside the battery compartment is set to work correctly in your location. Switch to N in the northern hemisphere or switch to S in the southern hemisphere.
- 4 Replace the battery compartment cover so that the tab on the cover fits in place.



Utilizing an External Power Supply

- 1 Use an external power supply with USB-minib plug (DC4.4V to 5.25V) for this purpose.
- 2 Connect to the USB-minib plug socket as shown in the photo.

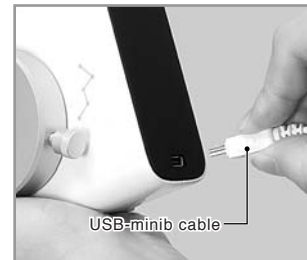

Note:

- If you connect the external power supply with the batteries inserted, the external power supply takes precedence over the batteries.
- Connecting the external power supply prevents the battery compartment cover from opening. Finish setting the S-N switch in the battery compartment before you connect the external power supply.

SETTING UP

Setting up the Polarie

This manual describes Polarie which comes with the M178-V tripod as a package. You may occasionally find descriptions in the text not relevant to your model. You should refer to the instruction manuals for your camera and tripod with this manual.

1 Place the tripod on even and solid ground so that you have a stable base for your photography. Loosen the extension clamp on the tripod leg and draw out the tripod leg until it is at the desired height.

Pull the tripod legs apart fully to let the tripod stand by itself. When necessary, change the height of the tripod by adjusting the tripod legs to be the same length

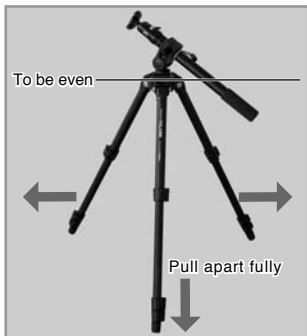
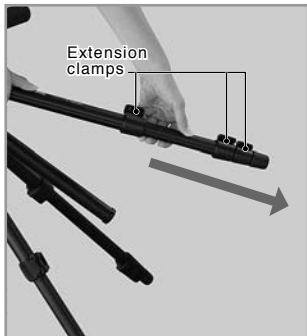

2 Mount the Polarie on the ball head adapter of the M178-V tripod. Attach the Polarie on the ball head adapter securely with the 1/4" thread screw and tighten the camera mounting dial securely as shown in the figure.



3 Loosen the two thumb screws and remove the camera mounting block from the Polarie as shown in the figure.

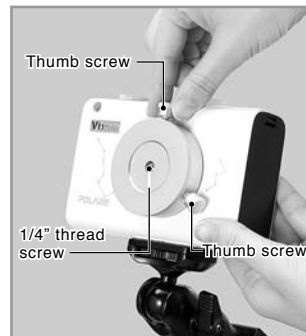

SETTING UP

- 4** Attach another ball head adapter to the camera mounting block. Push the 1/4" thread screw protruding from the center on the underside of the camera mounting block so that the 1/4" thread screw is pushed out on front side. Attach the ball head adapter on the camera mounting block with the protruded 1/4" thread screw and fix it securely by turning the camera mounting block as shown in the figure.

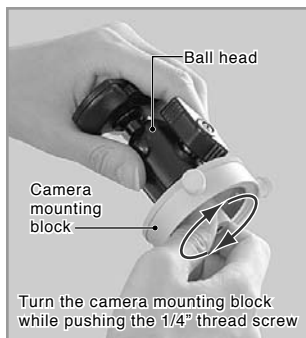
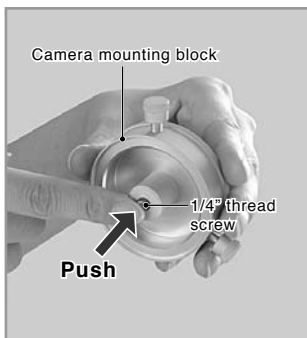

- 5** Put the camera mounting block back on the Polarie and fix it securely with the two thumb screws.



- 6** Attach the camera onto the ball head-mounted Polarie. Make sure that the camera is installed securely on the ball head adapter with the camera mounting dial fully tightened.



Note: Be sure to securely hold the camera with your hand while attaching it to avoid dropping the camera from the ball head adapter. Also, make sure that all the screws and lock levers are fastened fully. Losing balance due to unlocked levers could damage the camera or lead to injury.



USING THE POLARIE

Flow of Operation

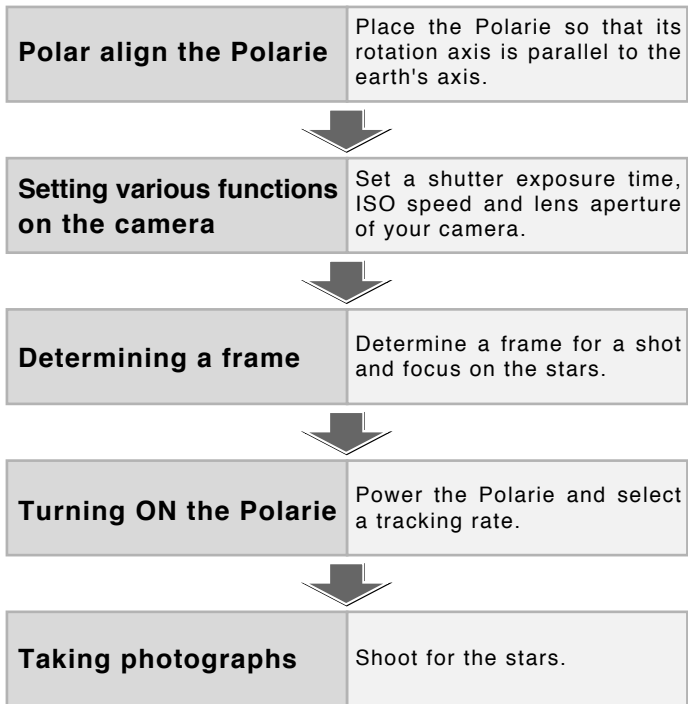

What is Polar Alignment?

The Polarie works as a star tracker when set up to follow diurnal motion of stars.

It is essential that the rotation axis of the Polarie is set to be parallel to that of the diurnal motion of the stars. This is called polar alignment.

Using the Polarie in the Northern Hemisphere

To set up the Polarie, you need to locate the polar star for both wide-field astrophotography and Star-Scape photography. The polar star is a 2nd magnitude star called Polaris. You can find Polaris easily using either of the following methods.



USING THE POLARIE

1. Find Polaris using a compass and the latitude of your location

1 Orient north using Polarie's compass and face the front side of the Polarie to the north. The compass is stored inside the cap on the back of the Polarie. Remove the cap by turning counter-clockwise to use the compass.

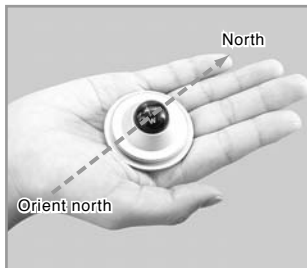

2 Polaris appears to remain at the same latitude during your photography session. It is roughly the same latitude as your location. Unlock the ball head and tilt the Polarie so that the built-in tilt meter points your latitude.



Note:

- Setting the mode dial to  position backlights the tilt meter in red.
- The tilt meter is designed only for a rough setting of the latitude.



3 Look through the polar sight hole and confirm that Polaris can be seen somewhere in the field of view.

In the event that Polaris is not there, uncover the cap on the back side of the Polarie and remove the front camera mounting block to make a wide viewing hole.

Readjust the orientation of the Polarie by slowly loosening the pan head grip of your tripod so that Polaris comes into the field of view of the polar sight hole.

Next, bring Polaris to the center of the polar sight's field of view and firmly lock the pan head again.

Note: If your view through the polar sight hole is blocked by the camera mounted on the Polarie, turn the camera to secure its field of view or remove the camera while aligning with Polaris.



USING THE POLARIE

2. Find Polaris from Cassiopeia and the Big Dipper

The constellations Cassiopeia and the Big Dipper (part of Ursa Major) are near Polaris. You will be able to find Polaris if you know the position of these groups of stars. Cassiopeia and the Big Dipper are autumn and spring constellations respectively. Either constellation is always above the eastern or western horizon most of the year.

1 Find Polaris using the guide map below. You will find it easier with the help of a compass since Polaris is located in the north.

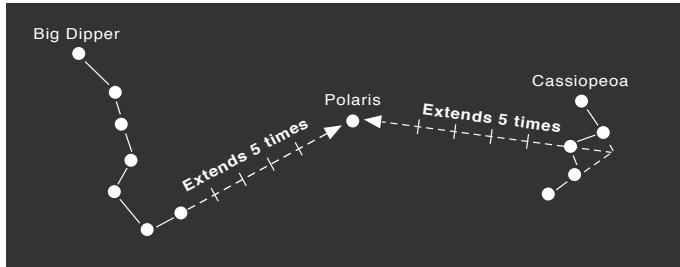

Directions 1:

Locate the two stars that form the outer edge of the Big Dipper as shown in the above map. Draw an imaginary line straight through the two stars of the dipper edge. You will see Polaris equidistant between the constellations.

Directions 2:

Cassiopeia looks like the letter “W” or the letter “M” depending on when you observe it. Draw imaginary lines from the stars that form the outer edges of the letter “W” so that the two lines intersect. Draw an imaginary line from the center of the “W” through the cross point of your first line. Extend it straight through by about 5 times to get to Polaris.

2 Turn the Polarie toward Polaris and look through the polar sight hole and confirm that Polaris is seen somewhere in the field of view.

USING THE POLARIE

Using the Polarie in the Southern Hemisphere

Octans is a constellation located near the south celestial pole and it can be used to align the Polarie in the southern hemisphere. Unlike Polaris which is a bright 2nd magnitude star adjacent to the north celestial pole, Octans is made up of dark stars about 5th magnitude on average.

The nearest star to the south celestial pole is Sigma Octantis, which is one of four stars forming a trapezoid in Octans, visible at 5.5th magnitude. There are a few methods to locate the inconspicuous Octans using the surrounding stars.

Note: Depending on the season of year, the orientation of the Octans changes.

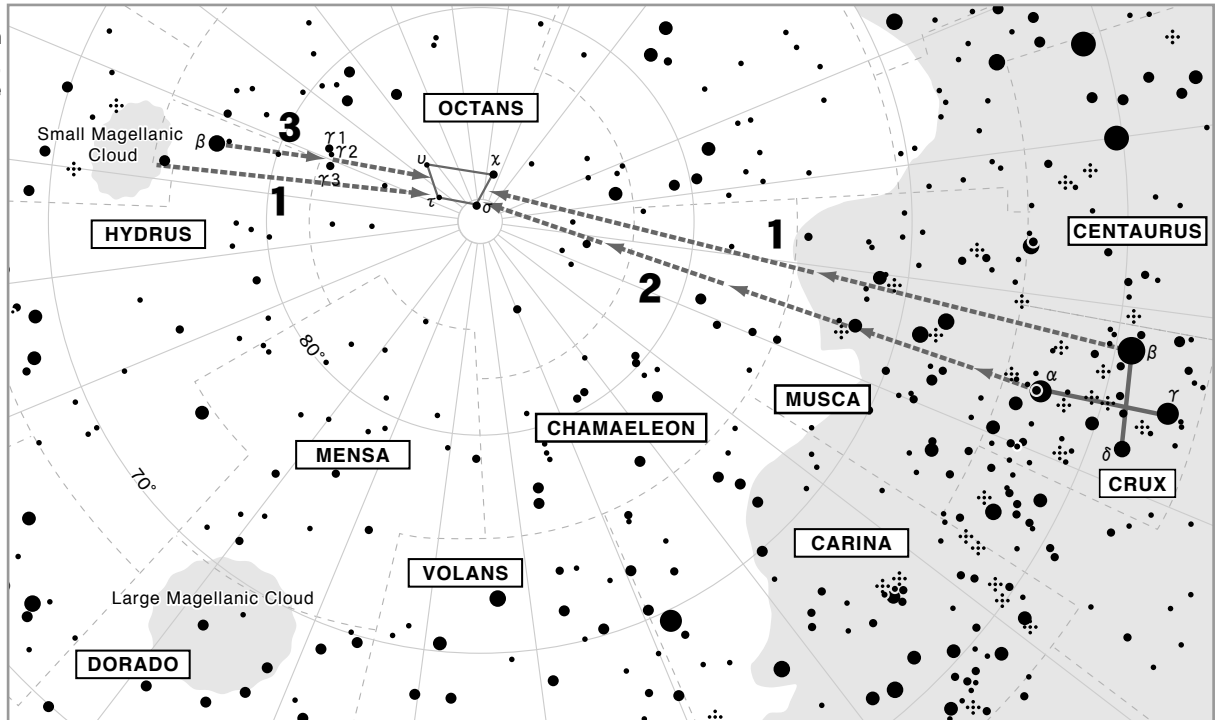

USING THE POLARIE

1. Find Octans using Small Magellanic Cloud and the Southern Cross (Crux) as pointers

Draw an imaginary line between the center of Small Magellanic Cloud and Beta Crux and divide it at a ratio of one to two. You will find the four stars of Octans at that location.

2. Find Octans using the arrangement of stars in the Southern Cross (Crux) as pointers

Draw an imaginary line straight through the two stars (Alpha and Beta Crux) of the Southern Cross making the vertical line of the cross toward the Small Magellanic Cloud. You will find the four stars of Octans at a place about 4.5 times extended from the span of the two stars.

3. Find Octans using Small Magellanic Cloud, Beta Hydrus and Gamma Octantis as pointers

If you look toward Crux from the Small Magellanic Cloud, you will see Beta Hydrus. Going southward from Beta Hydrus will find you Gamma Octans which consists of a row of three stars. Continue looking the same distance toward the Southern Cross and you will find the four stars of Octans.

Point the Polarie to the South Celestial Pole

Uncover the cap on the back side of the Polarie and remove the front camera mounting block to make a wide look-through hole so that you can secure about 14 degrees of field of view.

There is a group of four stars which forms a trapezoid in Octans. The stars are Sigma (σ), Tau (τ), Chi (χ) and Upsilon (υ) Octantis. Look through the hole and confirm if the four stars of Octans can be seen in the center of the hole. You should use a binocular with 6 to 8 magnifying power to locate the four stars if the sky is not dark enough.

While looking through the polar sight hole, readjust the Polarie in the direction of the south celestial pole so that Sigma Octantis comes nearest to the center of its field of view.

Note: It is recommended to use an optional Polar axis finder for Polarie for better pointing accuracy.

USING THE POLARIE

Basic Camera Settings

Set camera's various modes, shutter exposure times and lens aperture values. For details refer to instruction manuals of your camera.

Setting the Parameters:

- ⦿ **Shutter Speed:**
Set to bulb (B).
- ⦿ **Lens Aperture (F-Stop):**
Fully open or stop the lens down by one or two steps.
- ⦿ **ISO Speed (Light Sensitivity):**
Doubling the ISO setting increases sensitivity but it will deteriorate image quality if boosted too much.
- ⦿ **Exposure Time:**
Longer exposures can gather more light to display faint images, but some star trailing may occur.
- ⦿ **Sharp Focus:**
Focus the lens manually to infinity or until the stars look as sharp as possible if the camera has "Live Focus" mode.

Note:

Switch the lens from Auto to Manual Focus.

Attach the zoom focus ring with tape when you put a dew heater around the lens.

- ⦿ **Determine Frame:**
The stars are hard to view through the camera's finder frame or on its LCD screen unless you are viewing a very bright star or planet. Instant results of digital cameras make it easy to check the captured images on the spot. It is recommended to take a test photo using the fastest ISO speed to pick up more stars for this purpose. Remember to change the ISO setting back.

Switching ON the Polarie

Turning the mode dial to power up the Polarie and selecting a mode for your planned imaging.

- The legend on the mode dial is backlit in red when the rotation is set for the northern hemisphere. The legend is backlit in green if the N-S switch is set for the southern hemisphere. The backlight will flicker if the batteries run low.

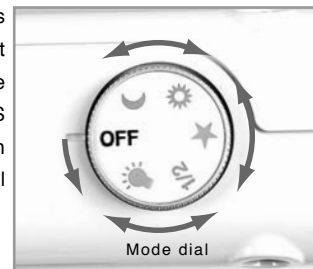

- The N-S change switch is next to the USB-minib plug socket in the battery compartment.



USING THE POLARIE

1/2 : Star-Scape Photography Mode

If this mode is selected, the Polarie tracks stars at half the speed of the diurnal motion of the stars. The terrestrial objects are trailed less as compared with images taken by wide-field photography at a given exposure time. Short exposure times will allow you to take images with no star trails. Photography at half the speed of the star's diurnal motion limits the movement seen in terrestrial objects. Adding landscape or architectural objects in the foreground will make your photos more impressive.

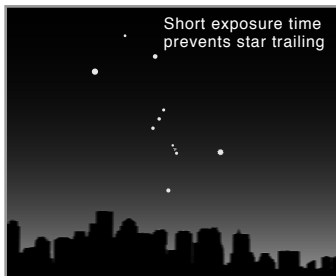

The table below shows recommended maximum shutter exposure times to hold pinpoint star images at Star-Scape mode.

Focal length of photographic lens(mm) Separation from the celestial equator ^{*1}	f=15mm	f=20mm	f=24mm	f=28mm	f=35mm	f=50mm	f=85mm	f=100mm
0° (Celestial equator)	18 sec.	13 sec.	11 sec.	9 sec.	7 sec.	5 sec.	3 sec.	2 sec.
± 10°	18 sec.	13 sec.	11 sec.	9 sec.	7 sec.	5 sec.	3 sec.	2 sec.
± 20°	19 sec.	14 sec.	12 sec.	10 sec.	8 sec.	5 sec.	3 sec.	2 sec.
± 30°	21 sec.	15 sec.	13 sec.	11 sec.	9 sec.	6 sec.	3 sec.	3 sec.
± 40°	23 sec.	17 sec.	14 sec.	12 sec.	10 sec.	7 sec.	4 sec.	3 sec.
± 50°	28 sec.	21 sec.	17 sec.	15 sec.	12 sec.	8 sec.	5 sec.	4 sec.
± 60°	36 sec.	27 sec.	22 sec.	19 sec.	15 sec.	10 sec.	6 sec.	5 sec.
± 70°	53 sec.	40 sec.	33 sec.	28 sec.	22 sec.	16 sec.	9 sec.	8 sec.
± 80°	105 sec.	78 sec.	65 sec.	56 sec.	45 sec.	31 sec.	18 sec.	15 sec.

[Diurnal Motion of Stars]

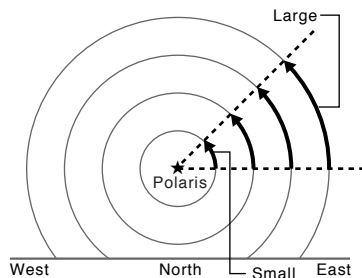

Note

*1: The above focal lengths show actual focal lengths of your camera. It is not necessary to convert them to focal lengths in 35mm film format if APS-C, 3/4 or other format is utilized for your camera.

*2: The above exposure times are calculated on the assumption that the pixel size of an imaging device is 0.001mm. Allowable maximum exposure times will change according to the specifications of your camera and lens. It is recommended you test your system to determine the best exposure time.

*3: The above exposure times will be extended by three times and more if you use a 35mm film format camera.

USING THE POLARIE

★ :Wide-Field Astrophotography Mode

If this mode is selected, the Polarie follows stars at the same speed as the diurnal motion of the stars. It is suitable for capturing dark stars and faint celestial objects. It is possible to avoid star trails but the terrestrial objects are trailed in long exposure.

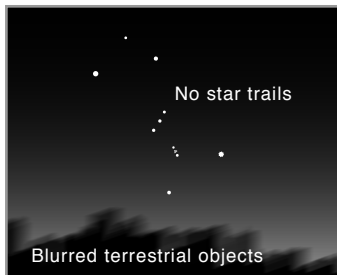

Note

- *1: The above focal lengths show actual focal lengths of your camera. It is not necessary to convert them to focal lengths in 35mm film format if APS-C, 3/4 or other format is utilized for your camera.
- *2: The above exposure times are calculated on the assumption that the pixel size of an imaging device is 0.001mm. Allowable maximum exposure times will change according to the specifications of your camera and lens. It is recommended you test your system to determine the best exposure time.
- *3: The above exposure times will be extended by three times and more if you use a 35mm film format camera.

The table below shows allowable maximum shutter exposure times to hold pinpoint star images subject to a polar alignment at an error of 2 degrees.

Focal length of photographic lens(mm) *1 Separation from the celestial equator	f=15mm	f=20mm	f=24mm	f=28mm	f=35mm	f=50mm	f=85mm	f=100mm
0° (Celestial equator)	6 min. 52 sec.	5 min. 09 sec.	4 min. 17 sec.	3 min. 41 sec.	2 min. 56 sec.	2 min. 03 sec.	1 min. 12 sec.	1 min. 01 sec.
± 10°	6 min. 58 sec.	5 min. 14 sec.	4 min. 21 sec.	3 min. 55 sec.	2 min. 59 sec.	2 min. 05 sec.	1 min. 13 sec.	1 min. 02 sec.
± 20°	7 min. 19 sec.	5 min. 29 sec.	4 min. 34 sec.	3 min. 55 sec.	3 min. 08 sec.	2 min. 11 sec.	1 min. 17 sec.	1 min. 05 sec.
± 30°	7 min. 56 sec.	5 min. 57 sec.	4 min. 57 sec.	4 min. 15 sec.	3 min. 24 sec.	2 min. 22 sec.	1 min. 24 sec.	1 min. 11 sec.
± 40°	8 min. 58 sec.	6 min. 43 sec.	5 min. 36 sec.	4 min. 48 sec.	3 min. 50 sec.	2 min. 41 sec.	1 min. 35 sec.	1 min. 20 sec.
± 50°	10 min. 41 sec.	8 min. 01 sec.	6 min. 41 sec.	5 min. 43 sec.	4 min. 35 sec.	3 min. 12 sec.	1 min. 53 sec.	1 min. 36 sec.
± 60°	13 min. 45 sec.	10 min. 18 sec.	8 min. 35 sec.	7 min. 22 sec.	5 min. 53 sec.	4 min. 07 sec.	2 min. 25 sec.	2 min. 03 sec.
± 70°	20 min. 06 sec.	15 min. 04 sec.	12 min. 33 sec.	10 min. 46 sec.	8 min. 36 sec.	6 min. 01 sec.	3 min. 32 sec.	3 min. 00 sec.
± 80°	39 min. 17 sec.	29 min. 41 sec.	24 min. 44 sec.	21 min. 12 sec.	16 min. 58 sec.	11 min. 52 sec.	6 min. 59 sec.	5 min. 56 sec.

☀ : Solar Tracking Mode ☾ Lunar Tracking Mode

Since the Sun and Moon appear to move across the sky at a different speed than the stars, Polarie includes a Solar and Lunar rate option. These rates are useful especially during an eclipse, allowing the user to maintain constant tracking on the object for up to 4 hours."

CAUTION: Never look directly at the sun with your naked eyes or through this product or a camera mounted on the Polarie. Permanent and irreversible eye damage may result.

SPECIFICATIONS

Polarie Star Tracker	
Type	Ultra compact (equatorial) tracking platform
Tracking Mode	Celestial tracking rate. 1/2 of celestial tracking rate. Solar tracking rate (Mean solar time). Lunar tracking rate (Mean lunar time) : Usable in both northern and southern hemispheres
Wheel gear	57.6mm dia. aluminum alloy axis with full-circle 144-tooth
Worm gear	9mm dia. high tension brass
Bearings	2 pieces
Drive	Pulse Motor (Stepper Motor)
Maximum Loading weight	2.0kg (4.4 lbs)
Polar sight hole	About 8.9° field of view
Tilt meter	Angles between 0° and 70° (5° increments)
Standard accessory	Compass
Working voltage	2 x AA-size battery : DC2.4~3.0V External power supply : DC4.4~5.25V
Operating temperature	0 degree to 40 degrees C (104 F)
Electricity consumption	DC3V.0.4A at a loading weight of 2.0kg (4.4 lbs)
Duration of operation	About 2 hours: At 20 C (68 F) degrees temperature, a 2.0kg (4.4 lbs) loading weight with use of Alkaline batteries
Dimensions	95x137x58mm (3.7x5.9x2.3 inches)
Weight	740g (26.1 oz) without batteries
Optional accessory	A dedicated polar axis scope for Polarie

SPECIFICATIONS

Tripod for Polarie (If purchased as a package)	
Model	M-178V
Tripod legs	4-section legs
Minimum tripod length	555mm (22")
Working height	Adjustable from 540mm to 1,780mm (21.2 to 70 inches)
Elevator pole extension	Geared part : 200mm (7.9"), Friction up and down part (Center column) : 290mm (11 4")
Camera thread size	UNC1/4 inch
Maximum loading weight	About 3.0kg (6.6 lbs)
Weight	Tripod : 1.98kg (4.3 lbs) without pan head QHD-33 Ball head adapter : 130g (4.58 oz) QHD-43 Ball head adapter : 158g (5.57 oz)
Standard accessory	QHD-43 (Pre-installed on the tripod head) and QHD-33 Ball head adapters

APPENDIX

Using an optional Polarie Polar Axis Scope

Your polar alignment on the Polarie can be improved with use of the dedicated polar axis scope sold separately.

Parts Descriptions

Time graduation circle
(10-minute increments)

Meridian offset scale
(Adjustable between
E20 and W20 at
5-degree increments)

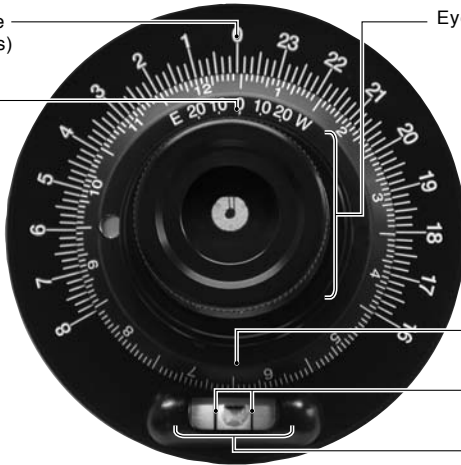

Eyepiece of the polar axis scope
(6x20 scope with 8-degree
field of view)

Date graduation circle
(2-day increments)

Line marks

Water level

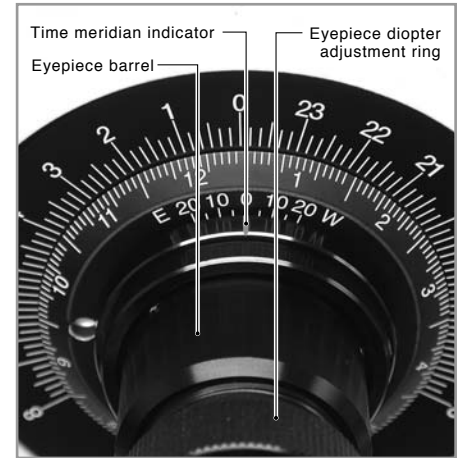

Time meridian indicator

Eyepiece barrel

Eyepiece diopter
adjustment ring

APPENDIX

Using the Polarie Polar Axis Scope in the Northern Hemisphere

1 Point the Polarie in the direction of north using its polar sight hole.



2 Look through the polar axis scope and turn the eyepiece diopter adjustment ring so that the reticle can be seen clearly.

3 Check the difference between the standard time meridian of your region and your observing site before you set up the Polarie.

If the observing site is east of standard time meridian, rotate the time meridian indicator in the direction as indicated E on the meridian offset scale.

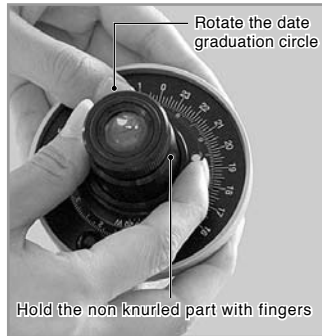

If the observing site is west of standard time meridian, rotate the time meridian indicator in the direction as indicated W on the meridian offset scale.

Example: If your location is Tokyo, which has a longitude of 139° E, you need to offset the standard time meridian indicator by 4° in the direction of E after you set to 0 degree on the meridian offset scale.

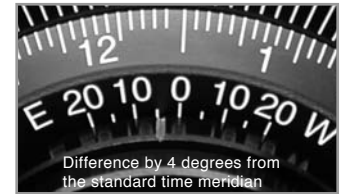

4 Match the date graduation circle with your observing time by turning the eyepiece. You can move the time meridian indicator by rotating the eyepiece while you hold the date graduation circle.

*The time and date graduation circles read 21h 40m on December 20th in the figure.



APPENDIX

- 5 Uncover the cap on the back side of the Polaris and remove the front camera mounting block.

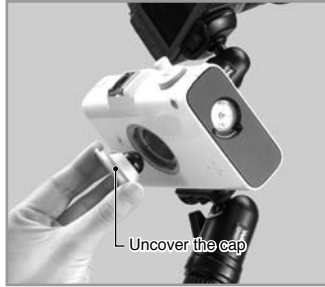

- 6 Insert the polar axis scope into the center opening hole of the Polaris until snug.



- 7 Turn the time graduation circle by holding the sides of the water level so that you bring the bubble to the middle of the level.

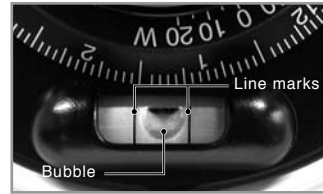

- 8 Look through the polar axis scope and confirm that Polaris can be seen somewhere in the field of view. Readjust the orientation of the Polaris by slowly loosening the pan head grip of your tripod so that is set at a designated position on the reticle in the field of view. If the field of view is too dim to see the reticle, point a dim red flashlight to the front of the polar axis scope to slightly illuminate the reticle.



Caution:

Lock the pan head securely when you have completed polar alignment. Be careful not to change the alignment.

APPENDIX

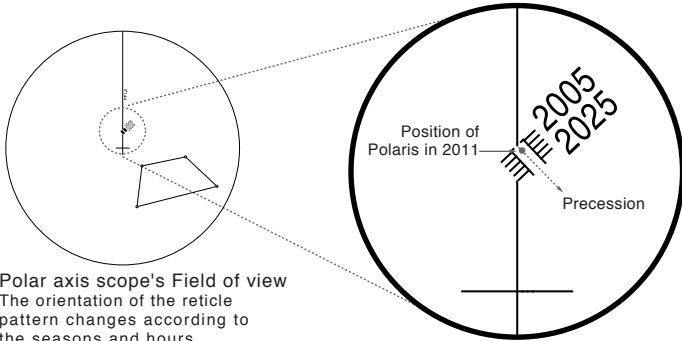

Polar axis scope's Field of view
The orientation of the reticle pattern changes according to the seasons and hours.

The position of the north celestial pole moves gradually each year due to precession. According to this, the position of Polaris shifts every year as shown in the figure. Place Polaris at a position on the alignment scale in the reticle to match the year of your observation, between 2005 and 2025.

9 Slowly remove the polar axis scope from the Polarie and replace the cap and camera mounting block.



Using the Polarie Polar Axis Scope in the Southern Hemisphere

- 1 Set up the Polarie mounted on the tripod on a level ground where you can see Octans in the sky. Point the Polarie in the direction of south by using the compass.
- 2 Refer to set up procedures 2, 5 and 6 that are described for the use in the northern hemisphere.
- 3 You see Octans in the field of view of the polar axis scope. Loosen the pan head slowly and place Octans at the set position in the reticle as shown in the figure by rotating the eyepiece of the polar axis scope.

The orientation of the reticle pattern changes according to the seasons and hours

Octantis	Magnitude
σ (Sigma)	5.5
χ (Chi)	5.2
τ (Tau)	5.6
υ (Upsilon)	5.7

Field of view of the polar axis scope

APPENDIX

- 4 Match the form of the Octantis four stars on the reticle with the four stars of Octans while looking through the polar axis scope.

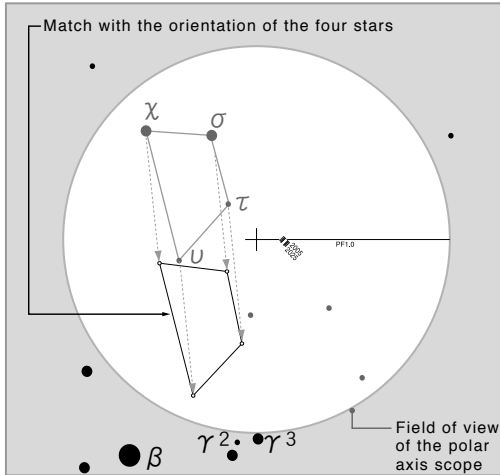

Loosen the pan head grip for adjustment

The orientation of the reticle pattern changes according to the seasons and hours.

- 5 Lock the pan head firmly after completing the polar alignment.

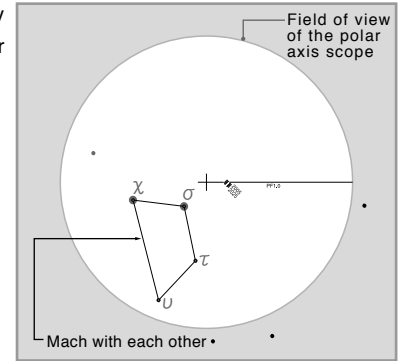

Note:

Take much care not to lose the balance of the Polarie when you loosen the lock of the pan head grip.

- 6 Slowly remove the polar axis scope from the Polarie and replace the cap and camera mounting block.



Vixen Co., Ltd. 5-17-3 Higashitokorozawa, Tokorozawa, Saitama 359-0021, Japan
.co.jp Phone +81-4-2944-4141(International)
F a x +81-4-2944-9722(International)

59ki-11-(80000094)-2S-84-(miz)(M)(k)